



### FEATURES:

- RoHS compliant
- High efficiency up to 82%
- Low profile plastic package
- 7 pin SIP package
- Operating temperature -40°C to + 105°C
- Continuous short circuit protection ‡
- Pin compatible with multiple manufacturers
- Up to 3000VDC Isolation

### Models

#### Single output



Model	Input Voltage (V)	Output Voltage (V)	Output Current max (mA)	Isolation (VDC)	Input Current Full Load   No Load (mA)		Max. Capacitive Load (µF)	Efficiency (%)
AM1DS-0303S-NZ*	3.0-3.6	3.3	303	1500	415	25	220	78
AM1DS-0305S-NZ*	3.0-3.6	5	200	1500	388	25	220	79
AM1DS-0505S-NZ	4.5-5.5	5	200	1500	250	20	220	80
AM1DS-0505SJZ	4.5-5.5	5	200	1500	250	10	2400	82
AM1DS-0509S-NZ	4.5-5.5	9	112	1500	250	20	220	80
AM1DS-0512S-NZ	4.5-5.5	12	83	1500	248	20	220	81
AM1DS-0515S-NZ	4.5-5.5	15	67	1500	248	20	220	81
AM1DS-0524S-NZ ‡	4.5-5.5	24	42	1500	248	20	220	81
AM1DS-1205S-NZ	10.8-13.2	5	200	1500	111	15	220	80
AM1DS-1209S-NZ	10.8-13.2	9	112	1500	92	15	220	80
AM1DS-1212S-NZ	10.8-13.2	12	83	1500	92	15	220	81
AM1DS-1215S-NZ	10.8-13.2	15	67	1500	90	15	220	81
AM1DS-1515S-NZ*	13.5-16.5	15	67	1500	84	10	220	80
AM1DS-2403S-NZ*	21.6-26.4	3.3	303	1500	56	7	220	79
AM1DS-2405S-NZ	21.6-26.4	5	200	1500	51	7	220	79
AM1DS-2412S-NZ	21.6-26.4	12	83	1500	52	7	220	81
AM1DS-2415S-NZ	21.6-26.4	15	67	1500	52	7	220	81
AM1DS-2424S-NZ ‡	21.6-26.4	24	42	1500	52	7	220	82
AM1DS-0305SH30-NZ*	3.0-3.6	5	200	3000	388	25	220	79
AM1DS-0505SH30-NZ	4.5-5.5	5	200	3000	250	20	220	80
AM1DS-0509SH30-NZ	4.5-5.5	9	112	3000	250	20	220	80
AM1DS-0512SH30-NZ	4.5-5.5	12	83	3000	248	20	220	80
AM1DS-0515SH30-NZ	4.5-5.5	15	67	3000	248	20	220	81
AM1DS-0524SH30-NZ ‡	4.5-5.5	24	42	3000	248	20	220	81
AM1DS-1205SH30-NZ	10.8-13.2	5	200	3000	111	15	220	80
AM1DS-1209SH30-NZ	10.8-13.2	9	112	3000	111	15	220	80
AM1DS-1212SH30-NZ	10.8-13.2	12	83	3000	92	15	220	81
AM1DS-1215SH30-NZ	10.8-13.2	15	67	3000	92	15	220	81
AM1DS-1224SH30-NZ ‡*	10.8-13.2	24	42	3000	92	15	220	80
AM1DS-2405SH30-NZ	21.6-26.4	5	200	3000	51	7	220	79
AM1DS-2409SH30-NZ	21.6-26.4	9	112	3000	51	7	200	80
AM1DS-2412SH30-NZ	21.6-26.4	12	83	3000	52	7	220	81
AM1DS-2415SH30-NZ	21.6-26.4	15	67	3000	52	7	220	81
AM1DS-2424SH30-NZ ‡	21.6-26.4	24	42	3000	52	7	220	82

### Models

#### Dual output

Model	Input Voltage (V)	Output Voltage (V)	Output Current max (Ma)	Isolation (VDC)	Input Current Full Load   No Load (mA)		Max. Capacitive Load (µF)	Efficiency (%)
AM1DS-0305D-NZ*	2.97-3.63	±5	±100	1500	274	20	100	78
AM1DS-0312D-NZ*	2.97-3.63	±12	±42	1500	248	20	100	78
AM1DS-0505D-NZ	4.5-5.5	±5	±100	1500	274	20	100	80
AM1DS-0509D-NZ	4.5-5.5	±9	±56	1500	250	20	100	80
AM1DS-0512D-NZ	4.5-5.5	±12	±42	1500	248	20	100	80
AM1DS-0515D-NZ	4.5-5.5	±15	±34	1500	248	20	100	81

AM1DS-0524D-NZ ‡	4.5-5.5	±24	±21	1500	248	20	100	81
AM1DS-1205D-NZ	10.8-13.2	±5	±100	1500	92	15	100	80
AM1DS-1212D-NZ	10.8-13.2	±12	±42	1500	92	15	100	81
AM1DS-1215D-NZ	10.8-13.2	±15	±34	1500	90	15	100	81
AM1DS-1512D-NZ*	13.5-16.5	±12	±42	1500	92	15	100	80
AM1DS-1515D-NZ	13.5-16.5	±15	±34	1500	84	10	100	80
AM1DS-2405D-NZ	21.6-26.4	±5	±100	1500	53	7	100	79
AM1DS-2412D-NZ	21.6-26.4	±12	±42	1500	51	7	100	81
AM1DS-2415D-NZ	21.6-26.4	±15	±34	1500	51	7	100	82
AM1DS-2424D-NZ‡	21.6-26.4	±24	±21	1500	51	7	100	82
<b>AM1DS-0505DH30-NZ</b>								
AM1DS-0505DH30-NZ	4.5-5.5	±5	±100	3000	274	20	100	80
AM1DS-0509DH30-NZ	4.5-5.5	±9	±56	3000	250	20	100	80
AM1DS-0512DH30-NZ	4.5-5.5	±12	±42	3000	248	20	100	80
AM1DS-0515DH30-NZ	4.5-5.5	±15	±34	3000	250	20	100	81
AM1DS-0524DH30-NZ ‡	4.5-5.5	±24	±21	3000	250	20	100	81
AM1DS-1205DH30-NZ	10.8-13.2	±5	±100	3000	248	20	100	81
AM1DS-1212DH30-NZ	10.8-13.2	±12	±42	3000	92	15	100	81
AM1DS-1215DH30-NZ	10.8-13.2	±15	±34	3000	90	15	100	79
AM1DS-1224DH30-NZ‡*	10.8-13.2	±24	±21	3000	90	15	100	79
AM1DS-2405DH30-NZ	21.6-26.4	±5	±100	3000	53	7	100	81
AM1DS-2409DH30-NZ	21.6-26.4	±9	±56	3000	53	7	100	81
AM1DS-2412DH30-NZ	21.6-26.4	±12	±42	3000	51	7	100	81
AM1DS-2415DH30-NZ	21.6-26.4	±15	±34	3000	51	7	100	82
AM1DS-2424DH30-NZ‡	21.6-26.4	±24	±21	3000	51	7	100	82

‡ With Momentary short circuit protection of 1 second

\* Reference in the Safety Table

NOTE: All specifications in this datasheet are measured at an ambient temperature of 25°C, humidity<75%, nominal input voltage and at rated output load unless otherwise specified.

## Input Specifications

Parameters	Nominal	Typical	Maximum	Units
Voltage range	3.3	2.97–3.63 or 3.0-3.6		VDC
	5	4.5-5.5		
	12	10.8-13.2		
	15	13.5-16.5		
	24	21.6-26.4		
Filter	Capacitor			
Absolute Maximum Rating	3.3		7	VDC
	5		9	
	12		18	
	15		21	
	24		30	
Peak Input Voltage time			1	s
No Load Input Current			50	mA

## Isolation Specifications

Parameters	Conditions	Typical	Rated	Units
Tested I/O voltage	60 sec		1500, 3000	VDC
Resistance		> 1000		MOhm
Capacitance		20		pF

## Output Specifications

Parameters	Conditions	Typical	Maximum	Units
Voltage accuracy		±5		%
Short Circuit protection	Continuous, unless marked with ‡			
Short circuit restart	Auto recovery			
Line voltage regulation	For 1.0% change of Vin	±1.2		% of Vin

Load voltage regulation	load 10~100%	15%	%
Temperature coefficient		±0.03	%/°C
Ripple & Noise	20MHz Bandwidth	(output 3.3/5/12) 30 (output 15/24) 60	mV p-p
Minimum Load Current		10	% of Max

## General Specifications

Parameters	Conditions	Typical	Maximum	Units
Switching frequency	100% load	100 - 300		KHz
Operating temperature	With derating above 85°C	-40 to +105		°C
Storage temperature		-55 to +125		°C
Maximum case temperature			100	°C
Derating		Not-Required		%/°C
Cooling		Free air convection		
Humidity			95	% RH
Case material		Non-conductive black plastic (UL94V-0 rated)		
Weight		2.3		g
Dimensions (L x W x H)		0.77 x 0.24 x 0.37inches	19.5 x 6.00 x 9.35mm	
MTBF		>3,500,000hrs (MIL-HDBK -217F, Ground Benign, t=+25°C)		
Maximum soldering temperature	1.5 mm from case for 10sec		300	°C

## Safety Specifications

Parameters	
Agency approvals	cULus (except the models marked with *)
Standards	UL 60950-1

## Derating

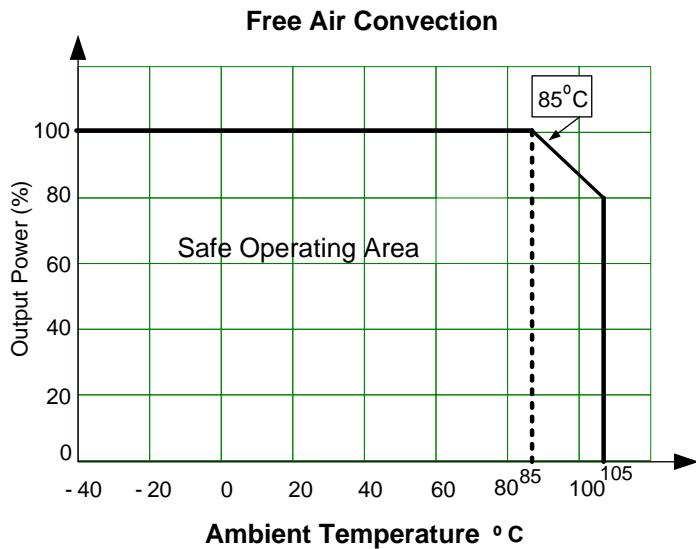

## EMI Recommended Circuit (Class B)

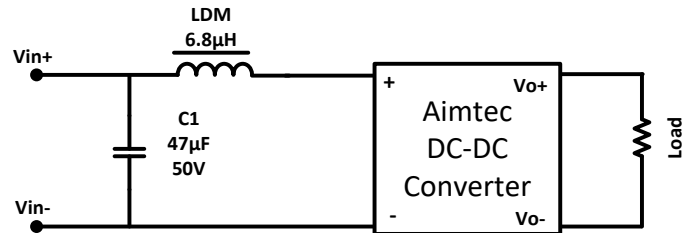

## Pin Out Specifications

Pin	1500 VDC		3000VDC	
	Single	Dual	Single	Dual
1	+ V Input	+ V Input	+ V Input	+ V Input
2	- V Input	- V Input	- V Input	- V Input
4	- V Output	- V Output	No pin	No pin
5	No pin	Common	- V Output	- V Output
6	+ V Output	+ V Output	No pin	Common
7	No pin	No pin	+ V Output	+ V Output

**Dimensions**

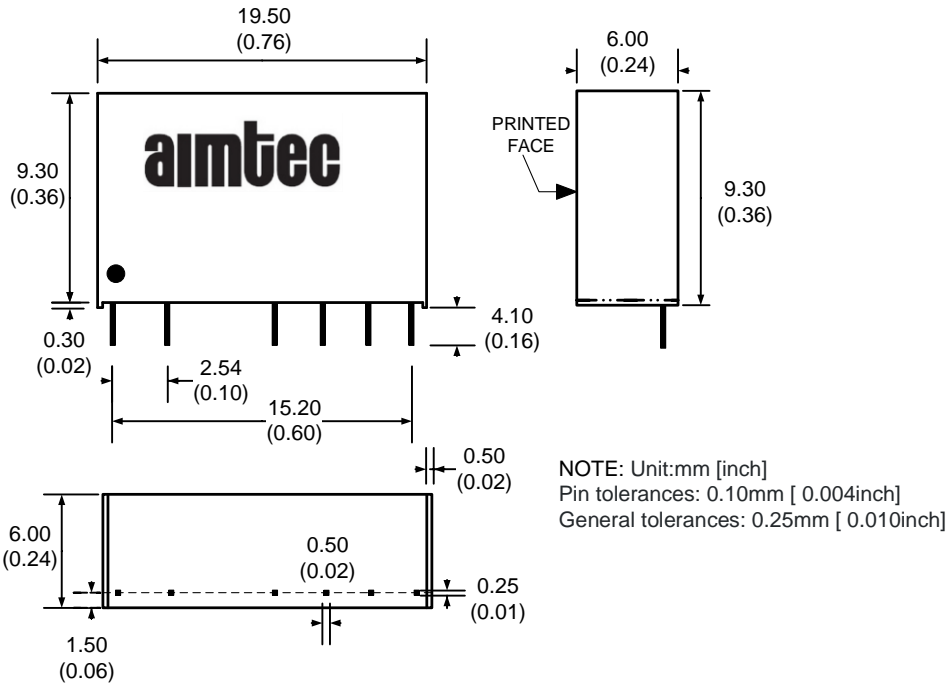

**Load Accuracy Tolerance Graph**

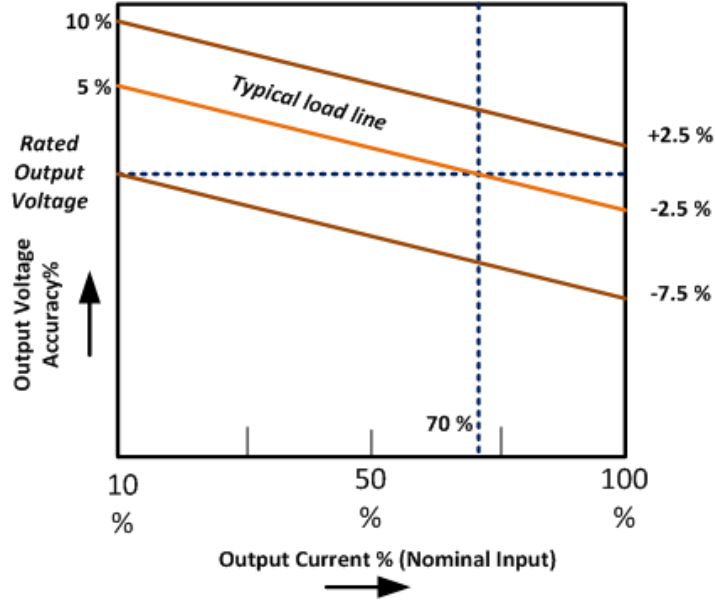

### Typical Recommended Circuit

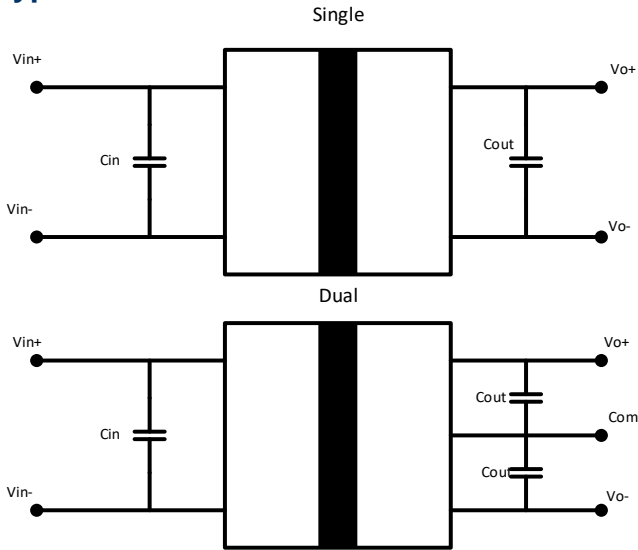

Vin	Cin	Vout	Cout	Vout (Dual)	Cout (Dual)
3.3 & 5 V	4.7	3.3 & 5 V	10 $\mu$ F	$\pm$ 3.3 & $\pm$ 5 V	4.7 $\mu$ F
12 V	2.2	12 V	2.2 $\mu$ F	$\pm$ 12 V	1 $\mu$ F
15 V	2.2	15 & 24 V	1 $\mu$ F	$\pm$ 15 & $\pm$ 24 V	0.47 $\mu$ F
24 V	1	-	-		

### Typical Efficiency Example Charts

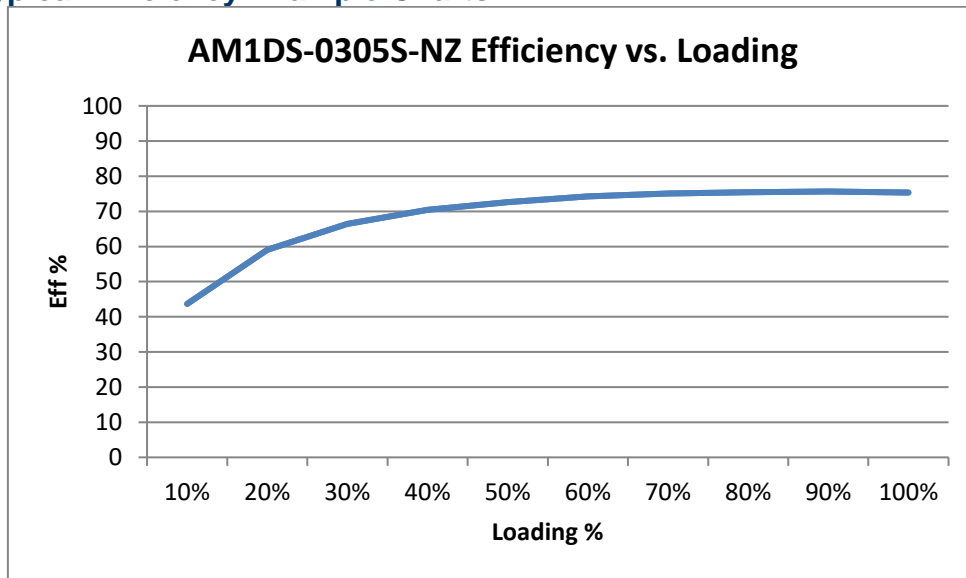

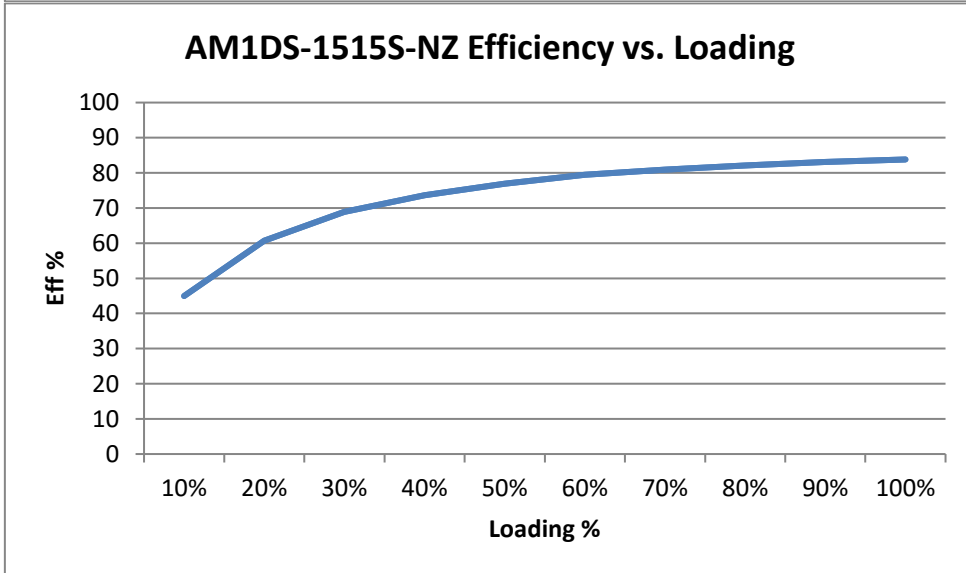
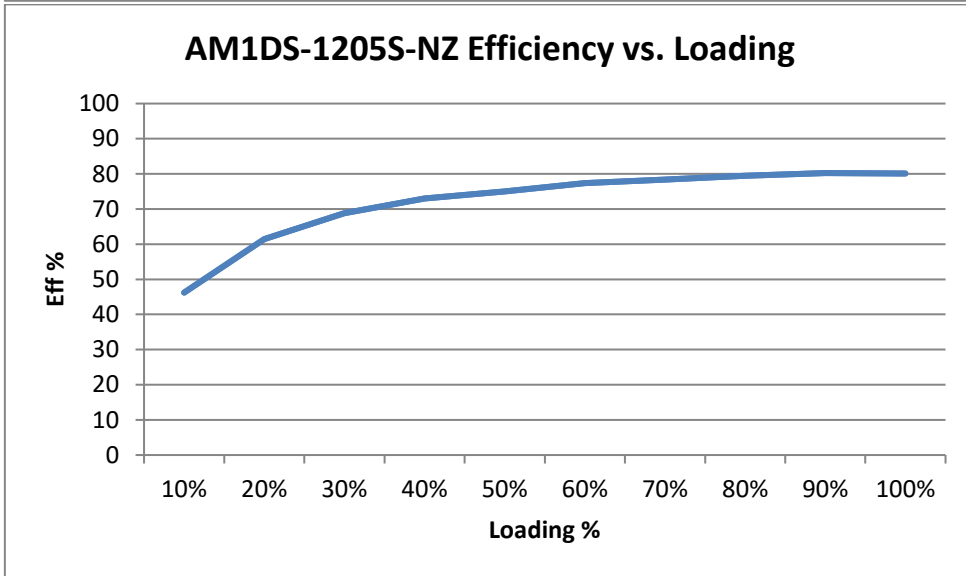
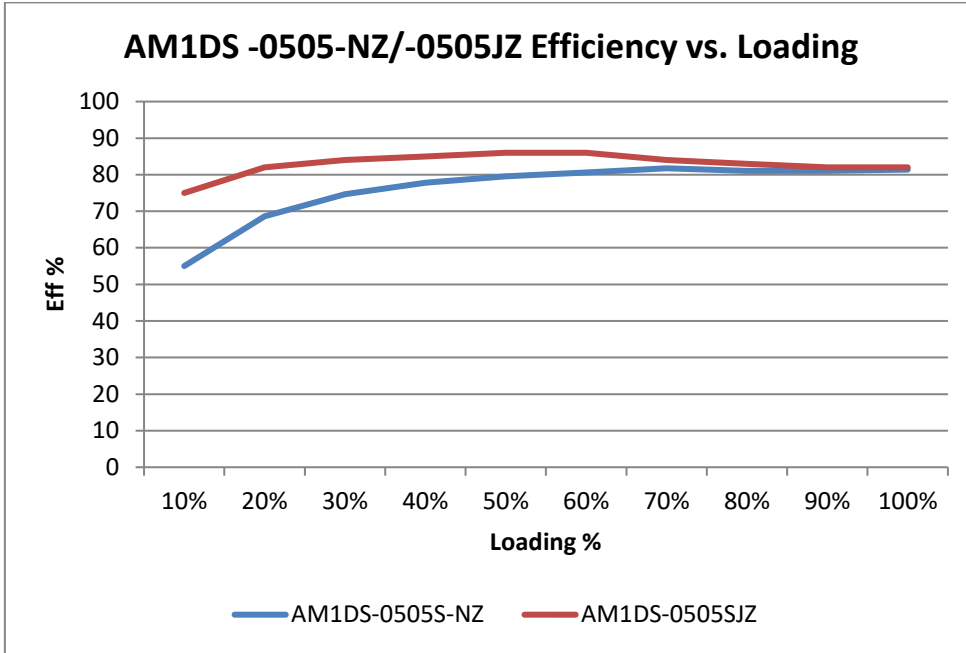

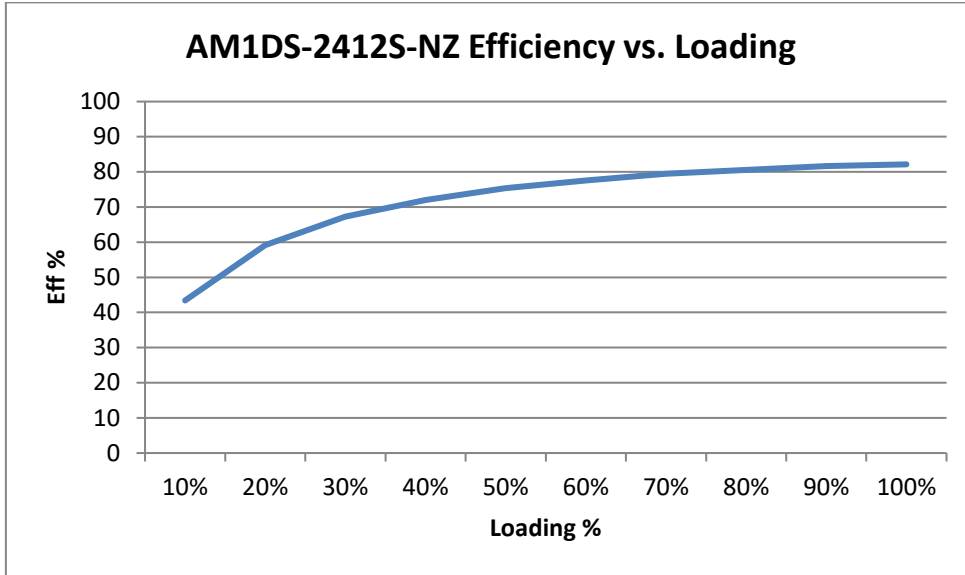

**NOTE:** **1.** Datasheets are updated as needed and as such, specifications are subject to change without notice. Once printed or downloaded, datasheets are no longer controlled by Aimtec; refer to [www.aimtec.com](http://www.aimtec.com) for the most current product specifications. **2.** Product labels shown, including safety agency certifications on labels, may vary based on the date manufactured. **3.** Mechanical drawings and specifications are for reference only. **4.** All specifications are measured at an ambient temperature of 25°C, humidity<75%, nominal input voltage and at rated output load unless otherwise specified. **5.** Aimtec may not have conducted destructive testing or chemical analysis on all internal components and chemicals at the time of publishing this document. CAS numbers and other limited information are considered proprietary and may not be available for release. **6.** This product is not designed for use in critical life support systems, equipment used in hazardous environments, nuclear control systems or other such applications which necessitate specific safety and regulatory standards other the ones listed in this datasheet. **7.** Warranty is in accordance with Aimtec's standard Terms of Sale available at [www.aimtec.com](http://www.aimtec.com).