



FEATURES:

- RoHS Compliant
- Low Ripple and Noise
- High Efficiency up to 82%
- 7 Pin SIP Package
- Operating Temperature -40°C to +85°C
- Pin Compatible with Multiple Manufacturers
- Isolation of 1000, 3000, 4000, 5200 & 6000 VDC



Models Single output

Model	Input Voltage (V)	Output Voltage (V)	Output Current Max (mA)	Input Current Full Load typ. No Load max.(mA)	Isolation (VDC)	Max Capacitive Load (µF)	Efficiency (%)
AM2D-0503SZ	4.5-5.5	3.3	400	367 30	1000	470	72
AM2D-0505SZ	4.5-5.5	5	400	512 30	1000	470	78
AM2D-0507SZ	4.5-5.5	7.2	277.7	500 30	1000	470	80
AM2D-0509SZ	4.5-5.5	9	222.2	500 30	1000	470	80
AM2D-0512SZ	4.5-5.5	12	166.7	487 30	1000	470	82
AM2D-0515SZ	4.5-5.5	15	133.3	487 30	1000	470	82
AM2D-0518SZ	4.5-5.5	18	111.1	487 30	1000	470	82
AM2D-0524SZ	4.5-5.5	24	83.3	487 30	1000	470	82
AM2D-1203SZ	10.8-13.2	3.3	400	169 36	1000	470	65
AM2D-1205SZ	10.8-13.2	5	400	216 20	1000	470	77
AM2D-1207SZ	10.8-13.2	7.2	277.7	208 20	1000	470	80
AM2D-1209SZ	10.8-13.2	9	222.2	208 20	1000	470	80
AM2D-1212SZ	10.8-13.2	12	166.7	203 20	1000	470	82
AM2D-1215SZ	10.8-13.2	15	133.3	203 20	1000	470	82
AM2D-1218SZ	10.8-13.2	18	111.1	208 20	1000	470	80
AM2D-1224SZ	10.8-13.2	24	83.3	208 20	1000	470	80
AM2D-2403SZ	21.6-26.4	3.3	400	76 10	1000	470	72
AM2D-2405SZ	21.6-26.4	5	400	105 10	1000	470	79
AM2D-2407SZ	21.6-26.4	7.2	277.7	104 10	1000	470	80
AM2D-2409SZ	21.6-26.4	9	222.2	104 10	1000	470	80
AM2D-2412SZ	21.6-26.4	12	166.7	102 10	1000	470	80
AM2D-2415SZ	21.6-26.4	15	133.3	101 10	1000	470	82
AM2D-2418SZ	21.6-26.4	18	111.1	101 10	1000	470	82
AM2D-2424SZ	21.6-26.4	24	83.3	104 10	1000	470	80
AM2D-0503SH30Z	4.5-5.5	3.3	400	367 30	3000	470	72
AM2D-0505SH30Z	4.5-5.5	5	400	512 30	3000	470	78
AM2D-0507SH30Z	4.5-5.5	7.2	277.7	500 30	3000	470	80
AM2D-0509SH30Z	4.5-5.5	9	222.2	500 30	3000	470	80
AM2D-0512SH30Z	4.5-5.5	12	166.7	487 30	3000	470	82
AM2D-0515SH30Z	4.5-5.5	15	133.3	487 30	3000	470	82
AM2D-0518SH30Z	4.5-5.5	18	111.1	487 30	3000	470	82
AM2D-0524SH30Z	4.5-5.5	24	83.3	487 30	3000	470	82
AM2D-1203SH30Z	10.8-13.2	3.3	400	169 36	3000	470	65
AM2D-1205SH30Z	10.8-13.2	5	400	216 20	3000	470	77
AM2D-1207SH30Z	10.8-13.2	7.2	277.7	208 20	3000	470	80
AM2D-1209SH30Z	10.8-13.2	9	222.2	208 20	3000	470	80
AM2D-1212SH30Z	10.8-13.2	12	166.7	203 20	3000	470	82
AM2D-1215SH30Z	10.8-13.2	15	133.3	203 20	3000	470	82
AM2D-1218SH30Z	10.8-13.2	18	111.1	208 20	3000	470	80
AM2D-1224SH30Z	10.8-13.2	24	83.3	208 20	3000	470	80
AM2D-2403SH30Z	21.6-26.4	3.3	400	76 10	3000	470	72
AM2D-2405SH30Z	21.6-26.4	5	400	105 10	3000	470	79
AM2D-2407SH30Z	21.6-26.4	7.2	277.7	104 10	3000	470	80
AM2D-2409SH30Z	21.6-26.4	9	222.2	104 10	3000	470	80
AM2D-2412SH30Z	21.6-26.4	12	166.7	102 10	3000	470	80
AM2D-2415SH30Z	21.6-26.4	15	133.3	101 10	3000	470	82

Models

Single output (continued)

Model	Input Voltage (V)	Output Voltage (V)	Output Current Max (mA)	Input Current Full Load typ. No Load max.(mA)		Isolation (VDC)	Max Capacitive Load (µF)	Efficiency (%)
AM2D-2418SH30Z	21.6-26.4	18	111.1	101	10	3000	470	82
AM2D-2424SH30Z	21.6-26.4	24	83.3	104	10	3000	470	80
AM2D-0503SH40Z	4.5-5.5	3.3	400	367	30	4000	470	72
AM2D-0505SH40Z	4.5-5.5	5	400	512	30	4000	470	78
AM2D-0507SH40Z	4.5-5.5	7.2	277.7	500	30	4000	470	80
AM2D-0509SH40Z	4.5-5.5	9	222.2	500	30	4000	470	80
AM2D-0512SH40Z	4.5-5.5	12	166.7	487	30	4000	470	82
AM2D-0515SH40Z	4.5-5.5	15	133.3	487	30	4000	470	82
AM2D-0518SH40Z	4.5-5.5	18	111.1	487	30	4000	470	82
AM2D-0524SH40Z	4.5-5.5	24	83.3	487	30	4000	470	82
AM2D-1203SH40Z	10.8-13.2	3.3	400	169	36	4000	470	65
AM2D-1205SH40Z	10.8-13.2	5	400	216	20	4000	470	77
AM2D-1207SH40Z	10.8-13.2	7.2	277.7	208	20	4000	470	80
AM2D-1209SH40Z	10.8-13.2	9	222.2	208	20	4000	470	80
AM2D-1212SH40Z	10.8-13.2	12	166.7	203	20	4000	470	82
AM2D-1215SH40Z	10.8-13.2	15	133.3	203	20	4000	470	82
AM2D-1218SH40Z	10.8-13.2	18	111.1	208	20	4000	470	80
AM2D-1224SH40Z	10.8-13.2	24	83.3	208	20	4000	470	80
AM2D-2403SH40Z	21.6-26.4	3.3	400	76	10	4000	470	72
AM2D-2405SH40Z	21.6-26.4	5	400	105	10	4000	470	79
AM2D-2407SH40Z	21.6-26.4	7.2	277.7	104	10	4000	470	80
AM2D-2409SH40Z	21.6-26.4	9	222.2	104	10	4000	470	80
AM2D-2412SH40Z	21.6-26.4	12	166.7	102	10	4000	470	80
AM2D-2415SH40Z	21.6-26.4	15	133.3	101	10	4000	470	82
AM2D-2418SH40Z	21.6-26.4	18	111.1	101	10	4000	470	82
AM2D-2424SH40Z	21.6-26.4	24	83.3	104	10	4000	470	80
AM2D-0503SH52Z	4.5-5.5	3.3	400	367	30	5200	470	72
AM2D-0505SH52Z	4.5-5.5	5	400	512	30	5200	470	78
AM2D-0507SH52Z	4.5-5.5	7.2	277.7	500	30	5200	470	80
AM2D-0509SH52Z	4.5-5.5	9	222.2	500	30	5200	470	80
AM2D-0512SH52Z	4.5-5.5	12	166.7	487	30	5200	470	82
AM2D-0515SH52Z	4.5-5.5	15	133.3	487	30	5200	470	82
AM2D-0518SH52Z	4.5-5.5	18	111.1	487	30	5200	470	82
AM2D-0524SH52Z	4.5-5.5	24	83.3	487	30	5200	470	82
AM2D-1203SH52Z	10.8-13.2	3.3	400	169	36	5200	470	65
AM2D-1205SH52Z	10.8-13.2	5	400	216	20	5200	470	77
AM2D-1207SH52Z	10.8-13.2	7.2	277.7	208	20	5200	470	80
AM2D-1209SH52Z	10.8-13.2	9	222.2	208	20	5200	470	80
AM2D-1212SH52Z	10.8-13.2	12	166.7	203	20	5200	470	82
AM2D-1215SH52Z	10.8-13.2	15	133.3	203	20	5200	470	82
AM2D-1218SH52Z	10.8-13.2	18	111.1	208	20	5200	470	80
AM2D-1224SH52Z	10.8-13.2	24	83.3	208	20	5200	470	80
AM2D-2403SH52Z	21.6-26.4	3.3	400	76	10	5200	470	72
AM2D-2405SH52Z	21.6-26.4	5	400	105	10	5200	470	79
AM2D-2407SH52Z	21.6-26.4	7.2	277.7	104	10	5200	470	80
AM2D-2409SH52Z	21.6-26.4	9	222.2	104	10	5200	470	80
AM2D-2412SH52Z	21.6-26.4	12	166.7	102	10	5200	470	80
AM2D-2415SH52Z	21.6-26.4	15	133.3	101	10	5200	470	82
AM2D-2418SH52Z	21.6-26.4	18	111.1	101	10	5200	470	82
AM2D-2424SH52Z	21.6-26.4	24	83.3	104	10	5200	470	80

Models

Single output (continued)

Model	Input Voltage (V)	Output Voltage (V)	Output Current Max (mA)	Input Current Full Load typ. No Load max.(mA)		Isolation (VDC)	Max Capacitive Load (µF)	Efficiency (%)
AM2D-0503SH60Z	4.5-5.5	3.3	400	500	30	6000	470	72
AM2D-0505SH60Z	4.5-5.5	5	400	487	30	6000	470	78
AM2D-0507SH60Z	4.5-5.5	7.2	277.7	487	30	6000	470	80
AM2D-0509SH60Z	4.5-5.5	9	222.2	487	30	6000	470	80
AM2D-0512SH60Z	4.5-5.5	12	166.7	487	30	6000	470	82
AM2D-0515SH60Z	4.5-5.5	15	133.3	169	36	6000	470	82
AM2D-0518SH60Z	4.5-5.5	18	111.1	216	20	6000	470	82
AM2D-0524SH60Z	4.5-5.5	24	83.3	208	20	6000	470	82
AM2D-1203SH60Z	10.8-13.2	3.3	400	208	20	6000	470	65
AM2D-1205SH60Z	10.8-13.2	5	400	203	20	6000	470	77
AM2D-1207SH60Z	10.8-13.2	7.2	277.7	203	20	6000	470	80
AM2D-1209SH60Z	10.8-13.2	9	222.2	208	20	6000	470	80
AM2D-1212SH60Z	10.8-13.2	12	166.7	208	20	6000	470	82
AM2D-1215SH60Z	10.8-13.2	15	133.3	76	10	6000	470	82
AM2D-1218SH60Z	10.8-13.2	18	111.1	105	10	6000	470	80
AM2D-1224SH60Z	10.8-13.2	24	83.3	104	10	6000	470	80
AM2D-2403SH60Z	21.6-26.4	3.3	400	104	10	6000	470	72
AM2D-2405SH60Z	21.6-26.4	5	400	102	10	6000	470	79
AM2D-2407SH60Z	21.6-26.4	7.2	277.7	101	10	6000	470	80
AM2D-2409SH60Z	21.6-26.4	9	222.2	101	10	6000	470	80
AM2D-2412SH60Z	21.6-26.4	12	166.7	104	10	6000	470	80
AM2D-2415SH60Z	21.6-26.4	15	133.3	45	6	6000	470	82
AM2D-2418SH60Z	21.6-26.4	18	111.1	102	10	6000	470	82
AM2D-2424SH60Z	21.6-26.4	24	83.3	100	13	6000	470	80

Models

Dual output

Model	Input Voltage (V)	Output Voltage (V)	Output Current Max (mA)	Input Current Full Load typ. No Load max.(mA)		Isolation (VDC)	Max Capacitive Load (µF)	Efficiency (%)
AM2D-0503DZ	4.5-5.5	±3.3	±200	406	30	1000	±220	65
AM2D-0505DZ	4.5-5.5	±5	±200	555	30	1000	±220	72
AM2D-0507DZ	4.5-5.5	±7.2	±138.8	555	30	1000	±220	72
AM2D-0509DZ	4.5-5.5	±9	±111.1	519	30	1000	±220	77
AM2D-0512DZ	4.5-5.5	±12	±83.3	512	38	1000	±220	78
AM2D-0515DZ	4.5-5.5	±15	±66.7	500	30	1000	±220	80
AM2D-0518DZ	4.5-5.5	±18	±55.6	500	30	1000	±220	80
AM2D-0524DZ	4.5-5.5	±24	±41.7	500	30	1000	±220	80
AM2D-1203DZ	10.8-13.2	±3.3	±200	164	20	1000	±220	67
AM2D-1205DZ	10.8-13.2	±5	±200	222	20	1000	±220	75
AM2D-1207DZ	10.8-13.2	±7.2	±138.8	219	20	1000	±220	76
AM2D-1209DZ	10.8-13.2	±9	±111.1	216	20	1000	±220	77
AM2D-1212DZ	10.8-13.2	±12	±83.3	203	20	1000	±220	82
AM2D-1215DZ	10.8-13.2	±15	±66.7	203	20	1000	±220	82
AM2D-1218DZ	10.8-13.2	±18	±55.6	203	20	1000	±220	82
AM2D-1224DZ	10.8-13.2	±24	±41.7	203	20	1000	±220	82
AM2D-2403DZ	21.6-26.4	±3.3	±200	80	10	1000	±220	68
AM2D-2405DZ	21.6-26.4	±5	±200	111	10	1000	±220	75
AM2D-2407DZ	21.6-26.4	±7.2	±138.8	111	10	1000	±220	75
AM2D-2409DZ	21.6-26.4	±9	±111.1	104	10	1000	±220	80
AM2D-2412DZ	21.6-26.4	±12	±83.3	101	10	1000	±220	82
AM2D-2415DZ	21.6-26.4	±15	±66.7	101	10	1000	±220	82
AM2D-2418DZ	21.6-26.4	±18	±55.6	101	10	1000	±220	82
AM2D-2424DZ	21.6-26.4	±24	±41.7	101	10	1000	±220	82

Models

Dual output (continued)

Model	Input Voltage (V)	Output Voltage (V)	Output Current Max (mA)	Input Current Full Load typ. No Load max.(mA)		Isolation (VDC)	Max Capacitive Load (µF)	Efficiency (%)
AM2D-0503DH30Z	4.5-5.5	±3.3	±200	406	30	3000	±220	65
AM2D-0505DH30Z	4.5-5.5	±5	±200	555	30	3000	±220	72
AM2D-0507DH30Z	4.5-5.5	±7.2	±138.8	555	30	3000	±220	72
AM2D-0509DH30Z	4.5-5.5	±9	±111.1	519	30	3000	±220	77
AM2D-0512DH30Z	4.5-5.5	±12	±83.3	512	38	3000	±220	78
AM2D-0515DH30Z	4.5-5.5	±15	±66.7	500	30	3000	±220	80
AM2D-0518DH30Z	4.5-5.5	±18	±55.6	500	30	3000	±220	80
AM2D-0524DH30Z	4.5-5.5	±24	±41.7	500	30	3000	±220	80
AM2D-1203DH30Z	10.8-13.2	±3.3	±200	164	20	3000	±220	67
AM2D-1205DH30Z	10.8-13.2	±5	±200	222	20	3000	±220	75
AM2D-1207DH30Z	10.8-13.2	±7.2	±138.8	219	20	3000	±220	76
AM2D-1209DH30Z	10.8-13.2	±9	±111.1	216	20	3000	±220	77
AM2D-1212DH30Z	10.8-13.2	±12	±83.3	203	20	3000	±220	82
AM2D-1215DH30Z	10.8-13.2	±15	±66.7	203	20	3000	±220	82
AM2D-1218DH30Z	10.8-13.2	±18	±55.6	203	20	3000	±220	82
AM2D-1224DH30Z	10.8-13.2	±24	±41.7	203	20	3000	±220	82
AM2D-2403DH30Z	21.6-26.4	±3.3	±200	80	10	3000	±220	68
AM2D-2405DH30Z	21.6-26.4	±5	±200	111	10	3000	±220	75
AM2D-2407DH30Z	21.6-26.4	±7.2	±138.8	111	10	3000	±220	75
AM2D-2409DH30Z	21.6-26.4	±9	±111.1	104	10	3000	±220	80
AM2D-2412DH30Z	21.6-26.4	±12	±83.3	101	10	3000	±220	82
AM2D-2415DH30Z	21.6-26.4	±15	±66.7	101	10	3000	±220	82
AM2D-2418DH30Z	21.6-26.4	±18	±55.6	101	10	3000	±220	82
AM2D-2424DH30Z	21.6-26.4	±24	±41.7	101	10	3000	±220	82
AM2D-0503DH40Z	4.5-5.5	±3.3	±200	406	30	4000	±220	65
AM2D-0505DH40Z	4.5-5.5	±5	±200	555	30	4000	±220	72
AM2D-0507DH40Z	4.5-5.5	±7.2	±138.8	555	30	4000	±220	72
AM2D-0509DH40Z	4.5-5.5	±9	±111.1	519	30	4000	±220	77
AM2D-0512DH40Z	4.5-5.5	±12	±83.3	512	38	4000	±220	78
AM2D-0515DH40Z	4.5-5.5	±15	±66.7	500	30	4000	±220	80
AM2D-0518DH40Z	4.5-5.5	±18	±55.6	500	30	4000	±220	80
AM2D-0524DH40Z	4.5-5.5	±24	±41.7	500	30	4000	±220	80
AM2D-1203DH40Z	10.8-13.2	±3.3	±200	164	20	4000	±220	67
AM2D-1205DH40Z	10.8-13.2	±5	±200	222	20	4000	±220	75
AM2D-1207DH40Z	10.8-13.2	±7.2	±138.8	219	20	4000	±220	76
AM2D-1209DH40Z	10.8-13.2	±9	±111.1	216	20	4000	±220	77
AM2D-1212DH40Z	10.8-13.2	±12	±83.3	203	20	4000	±220	82
AM2D-1215DH40Z	10.8-13.2	±15	±66.7	203	20	4000	±220	82
AM2D-1218DH40Z	10.8-13.2	±18	±55.6	203	20	4000	±220	82
AM2D-1224DH40Z	10.8-13.2	±24	±41.7	203	20	4000	±220	84
AM2D-2403DH40Z	21.6-26.4	±3.3	±200	80	10	4000	±220	68
AM2D-2405DH40Z	21.6-26.4	±5	±200	111	10	4000	±220	75
AM2D-2407DH40Z	21.6-26.4	±7.2	±138.8	111	10	4000	±220	75
AM2D-2409DH40Z	21.6-26.4	±9	±111.1	104	10	4000	±220	80
AM2D-2412DH40Z	21.6-26.4	±12	±83.3	101	10	4000	±220	82
AM2D-2415DH40Z	21.6-26.4	±15	±66.7	101	10	4000	±220	82
AM2D-2418DH40Z	21.6-26.4	±18	±55.6	101	10	4000	±220	82
AM2D-2424DH40Z	21.6-26.4	±24	±41.7	101	10	4000	±220	82

Models

Dual output (continued)

Model	Input Voltage (V)	Output Voltage (V)	Output Current Max (mA)	Input Current Full Load typ. No Load max.(mA)		Isolation (VDC)	Max Capacitive Load (µF)	Efficiency (%)
AM2D-0503DH52Z	4.5-5.5	±3.3	±200	406	30	5200	±220	65
AM2D-0505DH52Z	4.5-5.5	±5	±200	555	30	5200	±220	72
AM2D-0507DH52Z	4.5-5.5	±7.2	±138.8	555	30	5200	±220	72
AM2D-0509DH52Z	4.5-5.5	±9	±111.1	519	30	5200	±220	77
AM2D-0512DH52Z	4.5-5.5	±12	±83.3	512	38	5200	±220	78
AM2D-0515DH52Z	4.5-5.5	±15	±66.7	500	30	5200	±220	80
AM2D-0518DH52Z	4.5-5.5	±18	±55.6	500	30	5200	±220	80
AM2D-0524DH52Z	4.5-5.5	±24	±41.7	500	30	5200	±220	80
AM2D-1203DH52Z	10.8-13.2	±3.3	±200	164	20	5200	±220	67
AM2D-1205DH52Z	10.8-13.2	±5	±200	222	20	5200	±220	75
AM2D-1207DH52Z	10.8-13.2	±7.2	±138.8	219	20	5200	±220	76
AM2D-1209DH52Z	10.8-13.2	±9	±111.1	216	20	5200	±220	77
AM2D-1212DH52Z	10.8-13.2	±12	±83.3	203	20	5200	±220	82
AM2D-1215DH52Z	10.8-13.2	±15	±66.7	203	20	5200	±220	82
AM2D-1218DH52Z	10.8-13.2	±18	±55.6	203	20	5200	±220	82
AM2D-1224DH52Z	10.8-13.2	±24	±41.7	203	20	5200	±220	82
AM2D-2403DH52Z	21.6-26.4	±3.3	±200	80	10	5200	±220	68
AM2D-2405DH52Z	21.6-26.4	±5	±200	111	10	5200	±220	75
AM2D-2407DH52Z	21.6-26.4	±7.2	±138.8	111	10	5200	±220	75
AM2D-2409DH52Z	21.6-26.4	±9	±111.1	104	10	5200	±220	80
AM2D-2412DH52Z	21.6-26.4	±12	±83.3	101	10	5200	±220	82
AM2D-2415DH52Z	21.6-26.4	±15	±66.7	101	10	5200	±220	82
AM2D-2418DH52Z	21.6-26.4	±18	±55.6	101	10	5200	±220	82
AM2D-2424DH52Z	21.6-26.4	±24	±41.7	101	10	5200	±220	82
AM2D-0503DH60Z	4.5-5.5	±3.3	±200	406	30	6000	±220	65
AM2D-0505DH60Z	4.5-5.5	±5	±200	555	30	6000	±220	72
AM2D-0507DH60Z	4.5-5.5	±7.2	±138.8	555	30	6000	±220	72
AM2D-0509DH60Z	4.5-5.5	±9	±111.1	519	30	6000	±220	77
AM2D-0512DH60Z	4.5-5.5	±12	±83.3	512	38	6000	±220	78
AM2D-0515DH60Z	4.5-5.5	±15	±66.7	500	30	6000	±220	80
AM2D-0518DH60Z	4.5-5.5	±18	±55.6	500	30	6000	±220	80
AM2D-0524DH60Z	4.5-5.5	±24	±41.7	500	30	6000	±220	80
AM2D-1203DH60Z	10.8-13.2	±3.3	±200	164	20	6000	±220	67
AM2D-1205DH60Z	10.8-13.2	±5	±200	222	20	6000	±220	75
AM2D-1207DH60Z	10.8-13.2	±7.2	±138.8	219	20	6000	±220	76
AM2D-1209DH60Z	10.8-13.2	±9	±111.1	216	20	6000	±220	77
AM2D-1212DH60Z	10.8-13.2	±12	±83.3	203	20	6000	±220	82
AM2D-1215DH60Z	10.8-13.2	±15	±66.7	203	20	6000	±220	82
AM2D-1218DH60Z	10.8-13.2	±18	±55.6	203	20	6000	±220	82
AM2D-1224DH60Z	10.8-13.2	±24	±41.7	203	20	6000	±220	82
AM2D-2403DH60Z	21.6-26.4	±3.3	±200	80	10	6000	±220	68
AM2D-2405DH60Z	21.6-26.4	±5	±200	111	10	6000	±220	75
AM2D-2407DH60Z	21.6-26.4	±7.2	±138.8	111	10	6000	±220	75
AM2D-2409DH60Z	21.6-26.4	±9	±111.1	104	10	6000	±220	80
AM2D-2412DH60Z	21.6-26.4	±12	±83.3	101	10	6000	±220	82
AM2D-2415DH60Z	21.6-26.4	±15	±66.7	101	10	6000	±220	82
AM2D-2418DH60Z	21.6-26.4	±18	±55.6	101	10	6000	±220	82
AM2D-2424DH60Z	21.6-26.4	±24	±41.7	101	10	6000	±220	82

Models
Dual separated output

Model	Input Voltage (V)	Output Voltage (V)	Output Current Max (mA)	Input Current Full Load typ. No Load max.(mA)		Isolation (VDC)	Max Capacitive Load (μF)	Efficiency (%)
AM2D-050303DZ	4.5-5.5	3.3 / 3.3	303 / 303	519	35	1000	±220	77
AM2D-050505DZ	4.5-5.5	5 / 5	200 / 200	512	35	1000	±220	78
AM2D-050707DZ	4.5-5.5	7.2 / 7.2	139 / 139	512	35	1000	±220	78
AM2D-050909DZ	4.5-5.5	9 / 9	111 / 111	512	35	1000	±220	78
AM2D-051212DZ	4.5-5.5	12 / 12	83 / 83	512	35	1000	±220	78
AM2D-051515DZ	4.5-5.5	15 / 15	67 / 67	506	35	1000	±220	79
AM2D-051818DZ	4.5-5.5	18 / 18	55 / 55	500	35	1000	±220	80
AM2D-052424DZ	4.5-5.5	24 / 24	41 / 41	500	35	1000	±220	80
AM2D-120303DZ	10.8-13.2	3.3 / 3.3	303 / 303	216	25	1000	±220	77
AM2D-120505DZ	10.8-13.2	5 / 5	200 / 200	216	25	1000	±220	77
AM2D-120707DZ	10.8-13.2	7.2 / 7.2	139 / 139	216	25	1000	±220	77
AM2D-120909DZ	10.8-13.2	9 / 9	111 / 111	216	25	1000	±220	77
AM2D-121212DZ	10.8-13.2	12 / 12	83 / 83	213	25	1000	±220	78
AM2D-121515DZ	10.8-13.2	15 / 15	67 / 67	213	25	1000	±220	78
AM2D-121818DZ	10.8-13.2	18 / 18	55 / 55	208	25	1000	±220	80
AM2D-122424DZ	10.8-13.2	24 / 24	41 / 41	208	25	1000	±220	80
AM2D-240303DZ	21.6-26.4	3.3 / 3.3	303 / 303	106	12	1000	±220	78
AM2D-240505DZ	21.6-26.4	5 / 5	200 / 200	106	12	1000	±220	78
AM2D-240707DZ	21.6-26.4	7.2 / 7.2	139 / 139	106	12	1000	±220	75
AM2D-240909DZ	21.6-26.4	9 / 9	111 / 111	106	12	1000	±220	78
AM2D-241212DZ	21.6-26.4	12 / 12	83 / 83	104	12	1000	±220	80
AM2D-241515DZ	21.6-26.4	15 / 15	67 / 67	104	12	1000	±220	80
AM2D-241818DZ	21.6-26.4	18 / 18	55 / 55	104	12	1000	±220	80
AM2D-242424DZ	21.6-26.4	24 / 24	41 / 41	104	12	1000	±220	80

Input Specifications

Parameters	Nominal	Typical	Maximum	Units
Voltage range	5	4.5-5.5		VDC
	12	10.8-13.2		VDC
	24	21.6-26.4		VDC
Filter	Capacitor			
Absolute Maximum Rating	5 Vin	0-7		VDC
	12 Vin	0-15		VDC
	24 Vin	0-28		VDC
Peak Input Voltage time		100		ms
Input Reflected Ripple Current*		20		mA p-p

* Measured with a 12μH source inductor.

Dual separated models are measured with a 12μH source inductor and a 47μF (ESR<1Ω at 100KHz) source capacitor.

Isolation Specifications

Parameters	Conditions	Typical	Rated	Units
Tested I/O voltage	60sec		1000, 3000, 4000, 5200, 6000	VDC
Resistance		> 1000		MOhm
Capacitance		60		pF

Output Specifications

Parameters	Conditions	Typical	Maximum	Units
Voltage accuracy		±3		%
Voltage balance	Dual output	±1		%
Line voltage regulation	For 1.0% of Vin	±1.2		%
Load voltage regulation	Load 20~100%	±10		%
Load voltage regulation	3.3V output model, Load 20~100%	±20		%

Temperature coefficient		±0.02		%/°C
Ripple & Noise	At 20MHz Bandwidth	75		mV p-p

General Specifications

Parameters	Conditions	Typical	Maximum	Units
Switching frequency	100% load	80		KHz
Operating temperature	Full Load	-40 to +85		°C
Storage temperature		-40 to +125		°C
Max Case temperature			+100	°C
Cooling	Free air convection			
Humidity			95	%
Case material	Plastic UL94-VO			
Weight	7.2mm width models Other models	2.7 2.3		g
Dimensions (L x W x H)	0.77 x 0.24 x 0.39 inch 0.77 x 0.28 x 0.39 inch	19.50 x 6.00 x 10.00 mm 19.50 x 7.20 x 10.00 mm		
MTBF	>1 121 000 hrs (MIL-HDBK -217F, Ground Benign, t=+25°C)			

NOTE: All specifications in this datasheet are measured at an ambient temperature of 25°C, humidity<75%, nominal input voltage and at rated output load unless otherwise specified

Safety Specifications

Parameters	
Standards	Design to meet IEC/EN/UL 60950-1, 62368-1
	EN55032 class B with the recommended EMI circuit (except dual separated models)
	IEC61000-4-2, Perf. Criteria A (except dual separated models)
	IEC61000-4-3, Perf. Criteria A (except dual separated models)
	IEC61000-4-4, Perf. Criteria A with a 470uF/100V capacitor (except dual separated models)
	IEC61000-4-5, Perf. Criteria A with a 470uF/100V capacitor (except dual separated models)
	IEC61000-4-6, Perf. Criteria A (except dual separated models)
	IEC61000-4-8, Perf. Criteria A (except dual separated models)

Pin Out Specifications

Pin	1000 VDC			3000, 4000 , 5200, 6000 VDC	
	Single	Dual	Dual separated	Single	Dual
1	+ V Input	+ V Input	+ V Input	+ V Input	+ V Input
2	- V Input	- V Input	- V Input	- V Input	- V Input
4	- V Output	- V Output	+V1 Output	No pin	No pin
5	No pin	Common	-V1 Output	-V Output	-V Output
6	+ V Output	+ V Output	+V2 Output	No pin	Common
7	No pin	No pin	-V2 Output	+V Output	+V Output

Dimensions for models listed in the 7.2mm width models table.

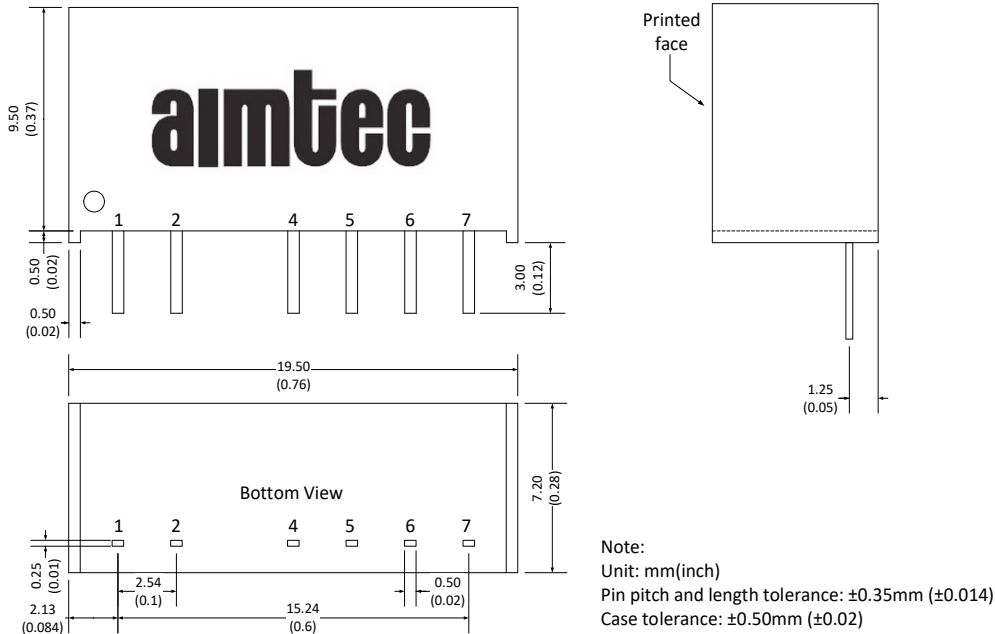

7.2mm width models	
AM2D-0505SH40Z	AM2D-051818DZ
AM2D-0505SH52Z	AM2D-052424DZ
AM2D-1203SH60Z	AM2D-120303DZ
AM2D-0507DH52Z	AM2D-120707DZ
AM2D-0507DH60Z	AM2D-120909DZ
AM2D-0515DH40Z	AM2D-121515DZ
AM2D-0515DH52Z	AM2D-121818DZ
AM2D-0515DH60Z	AM2D-122424DZ
AM2D-1205DH52Z	AM2D-240303DZ
AM2D-050303DZ	AM2D-241515DZ
AM2D-050505DZ	AM2D-241818DZ
AM2D-050707DZ	AM2D-242424DZ
AM2D-050909DZ	-
AM2D-051212DZ	-

Dimensions for others

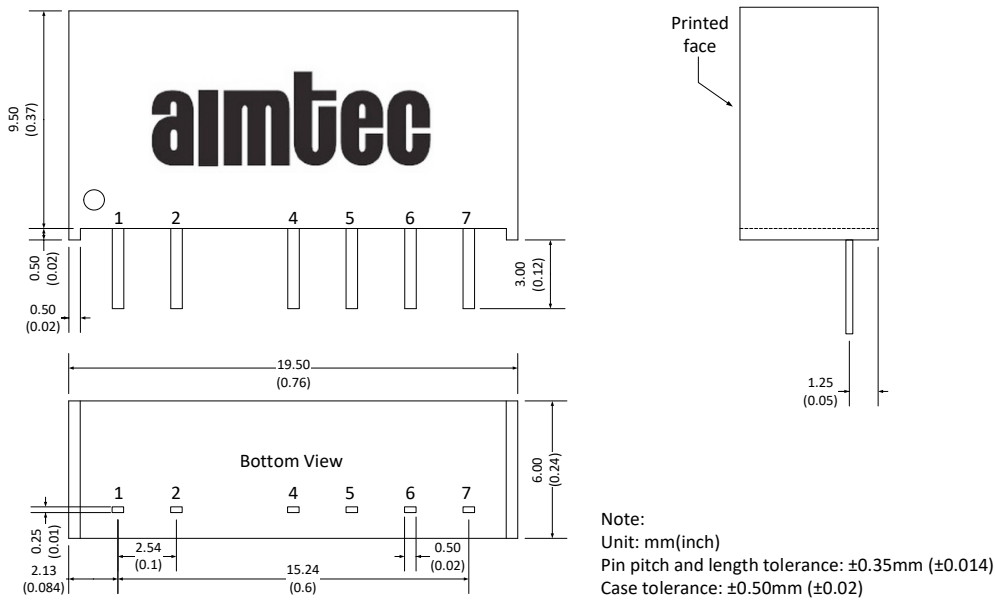

Recommended EMI Circuit

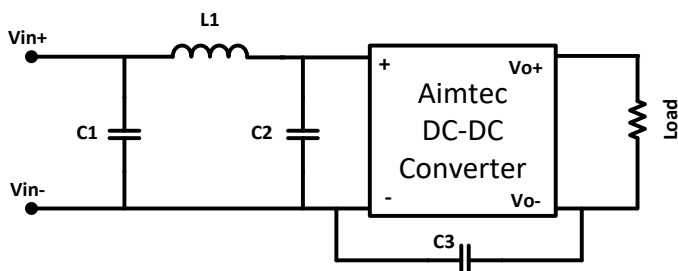

V_{in}	C1	L1	C2	C3
5Vin	2.2 $\mu\text{F}/100\text{V}$	18 μH	-	-
12Vin	2.2 $\mu\text{F}/100\text{V}$	18 μH	-	-
15Vin	2.2 $\mu\text{F}/100\text{V}$	18 μH	-	-
24Vin	2.2 $\mu\text{F}/100\text{V}$	18 μH	2.2 $\mu\text{F}/100\text{V}$	470 pF/2kV

Typical Efficiency Chart Examples

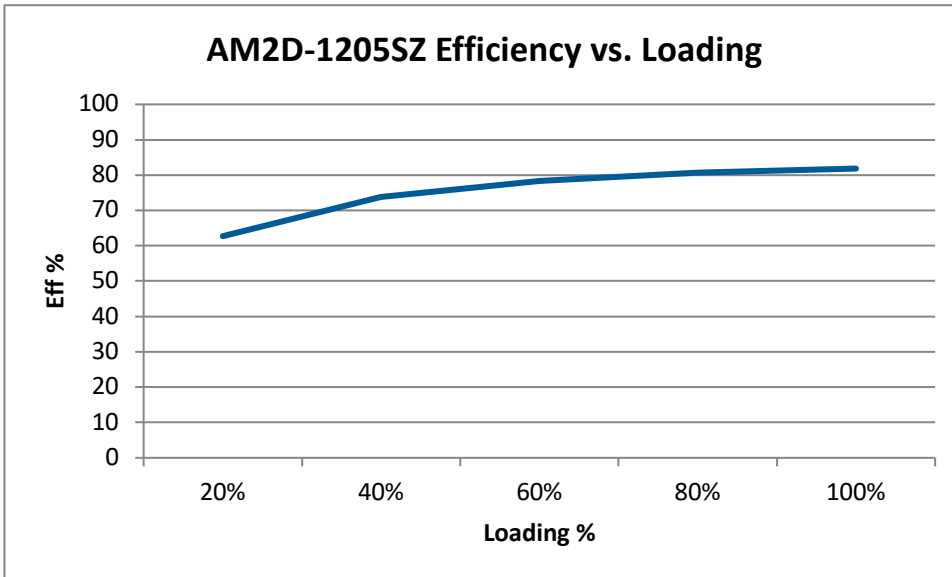
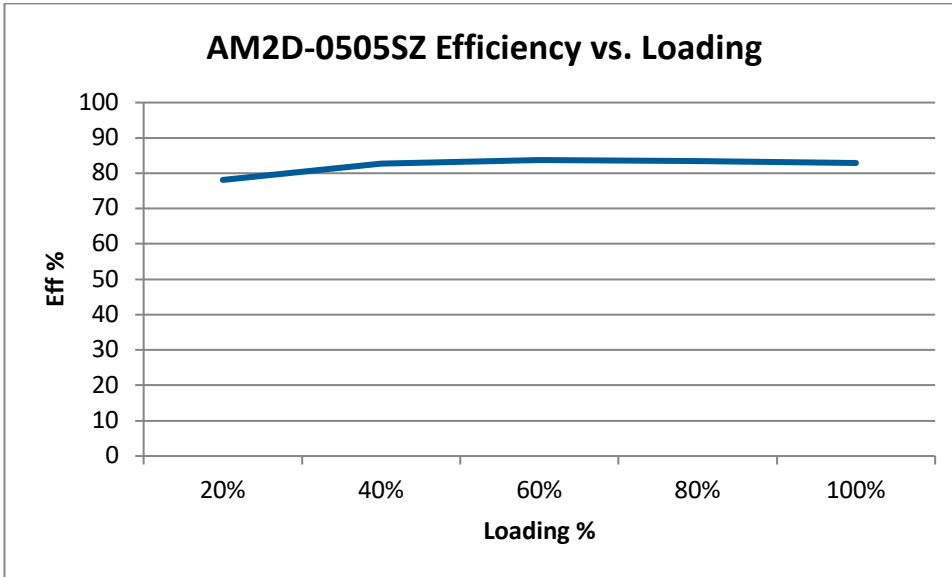

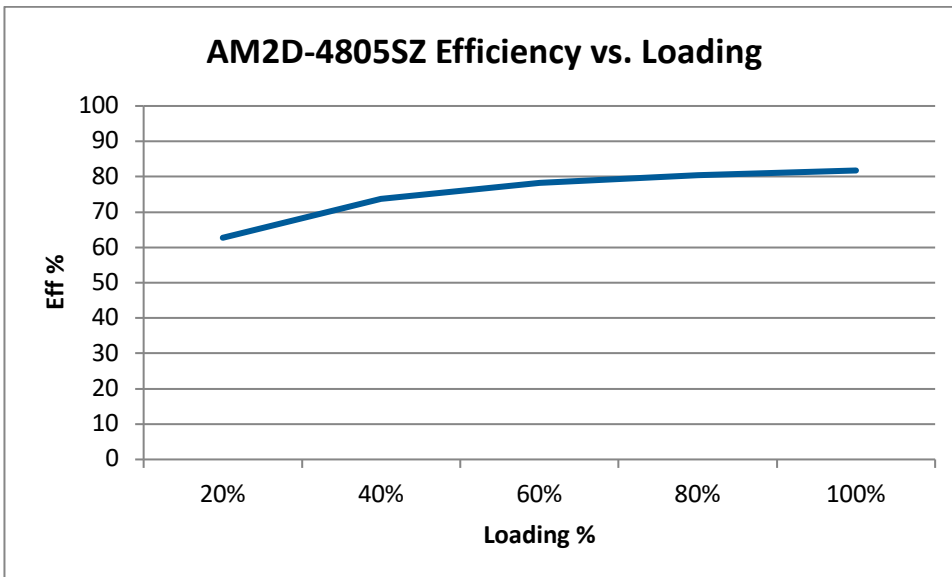
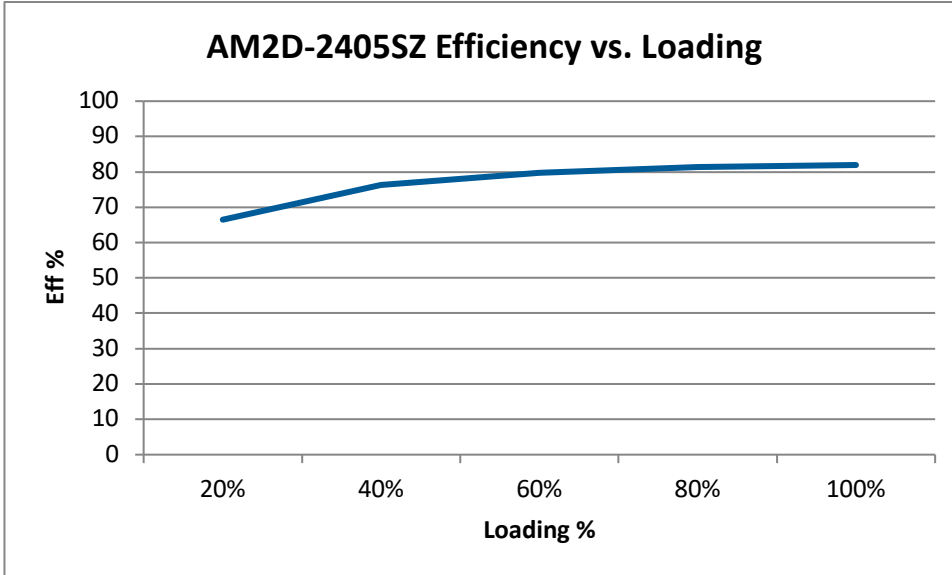

NOTE: 1. Datasheets are updated as needed and as such, specifications are subject to change without notice. Once printed or downloaded, datasheets are no longer controlled by Aimtec; refer to www.aimtec.com for the most current product specifications. 2. Product labels shown, including safety agency certifications on labels, may vary based on the date manufactured. 3. Mechanical drawings and specifications are for reference only. 4. All specifications are measured at an ambient temperature of 25°C, humidity < 75%, nominal input voltage and at rated output load unless otherwise specified. 5. Aimtec may not have conducted destructive testing or chemical analysis on all internal components and chemicals at the time of publishing this document. CAS numbers and other limited information are considered proprietary and may not be available for release. 6. This product is not designed for use in critical life support systems, equipment used in hazardous environments, nuclear control systems or other such applications which necessitate specific safety and regulatory standards other than the ones listed in this datasheet. 7. Warranty is in accordance with Aimtec's standard Terms of Sale available at www.aimtec.com.