



Your Power Partner

Series AMSR2-78-NZ

Up to 13 Watt | DC-DC Switching Regulator



FEATURES:

- 3 Pin SIP Package
- Pin-out compatible with LM78XX Linear Regulators
- Continuous Short Circuit Protection
- Non-Isolated Regulated Outputs
- Operating temperature -40°C to +85°C
- Wide input range
- Very High Efficiency Up To 92%
- Low ripple and noise



Models Single output

Model	Input Voltage (V)	Output Voltage (V)	Output Current max (A)	Efficiency Vin Min (%)	Efficiency Vin Max (%)
AMSR2-786.5-NZ	8.5-18	6.5	2	92	91
AMSR2-786.5L-NZ	8.5-18	6.5	2	92	91

NOTE: All specifications in this datasheet are measured at an ambient temperature of 25°C, humidity < 75%, nominal input voltage and at rated output load unless otherwise specified.

Input Specifications

Input Specifications	Nominal	Typical	Maximum	Units
Voltage range	See the table above			VDC
Filter	Capacitor			
Quiescent Current	Vin=(LL-HL) at full load	5	10	mA

Output Specifications

Output Specifications	Conditions	Typical	Maximum	Units
Voltage accuracy	100% load	±3		%
Short Circuit protection		Continuous.		
Short circuit restart		Auto recovery		
Output current limit			5	A
Thermal shutdown	Internal IC junction	150		°C
Dynamic load stability	10-100% load		±100	mV
Line voltage regulation	Vin=(LL-HL) at full load	±0.75		%
Load voltage regulation	10-100% load	±1		%
Temperature coefficient	-40°C to +85°C ambient	±0.03		%/°C
Ripple & Noise	20MHz Bandwidth	45		mV p-p
Maximum Capacitive Load			1000	µF

General Specifications

Input Specifications	Conditions	Typical	Maximum	Units
Switching frequency	100% load	340		KHz
Operating temperature	With derating above 71°C	-40 to +85		°C
Storage temperature		-55 to +125		°C
Max Case temperature			100	°C
Cooling		Free air convection		
Humidity			95	%
Case material	Non-conductive black plastic (UL94-V0 rated)			
Weight		4		g
Dimensions (L x W x H)		0.45 X 0.35 X 0.69 inch	11.50 X 8.90 X 17.50 mm	
MTBF	> 2 000 000 hrs (MIL-HDBK-217F, Ground Benign, t=+25°C)			
Soldering Temperature	1.5 mm from case for 10 sec		300	°C

Safety Specifications

Parameters	
Approvals	CE, UL
Standards	EN/IEC/UL60950-1

Pin Out Specifications

Pin	Single
1	+Vin
2	GND
3	+Vout

Dimensions

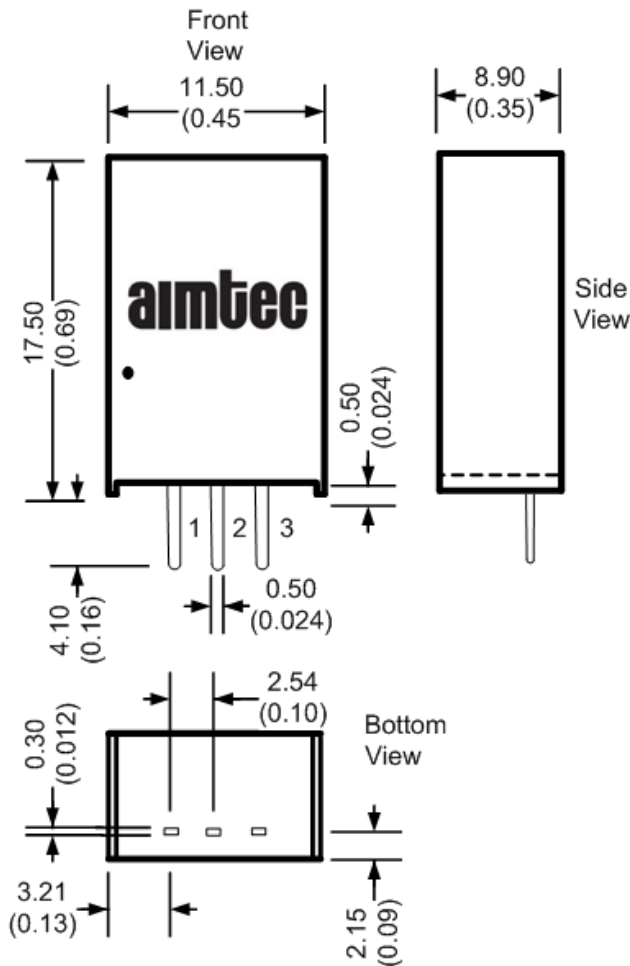

Footprint

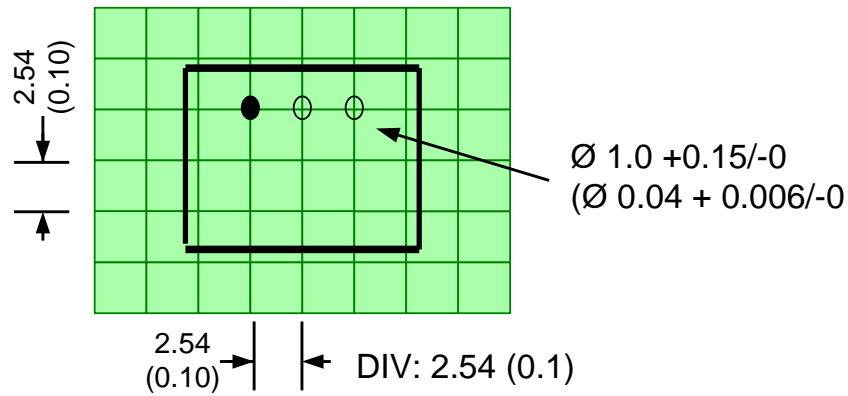

Dimensions are typical values: mm (inch)
 General Tolerance: ± 0.25 (± 0.01)
 Pin Tolerance: ± 0.1 (± 0.004)

L Models

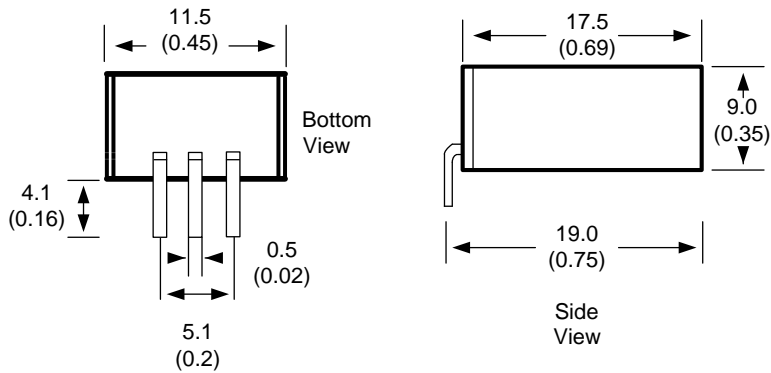

Footprint

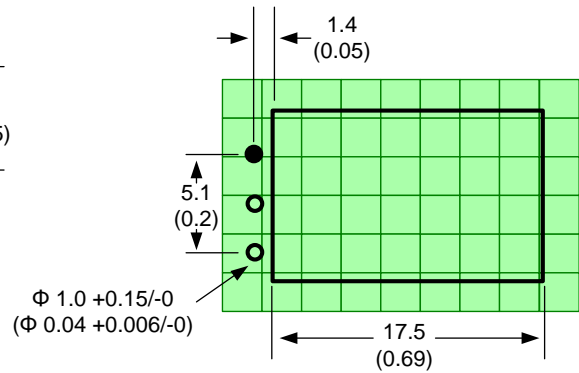

Derating

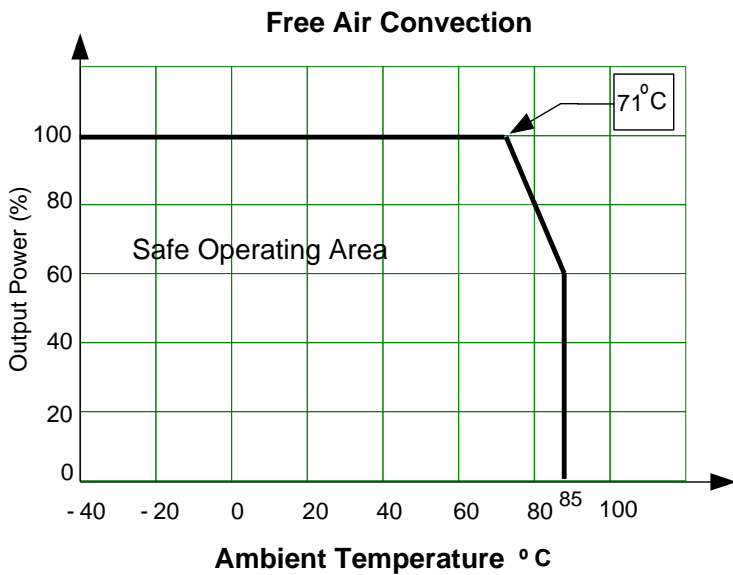

Typical Application Circuit

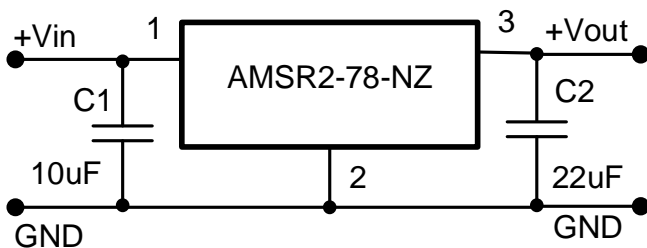

C1: A low ESR capacitor is required to keep the noise of the converter to a minimum. Ceramic capacitors are recommended with typical value is 10µF / 25V.

C2: Installation of C2 is recommended with typical value of 22µF / 16V ceramic for 6.5V output signal.

NOTE: This part is not designed for parallel operation.

Dual Output Connection

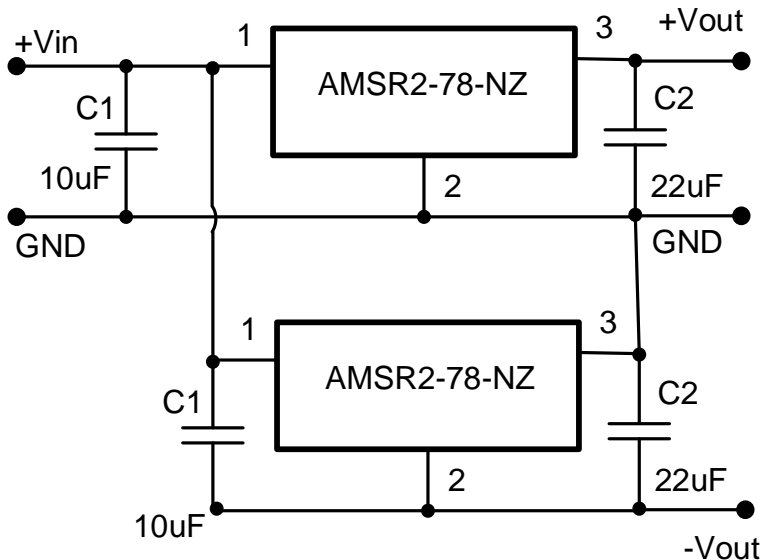

Input Filter

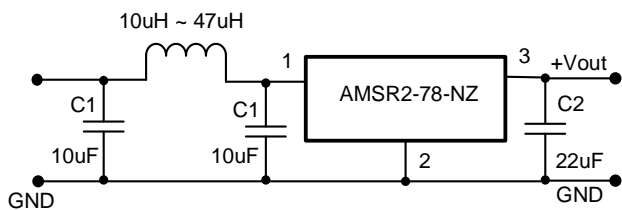

Output Filter

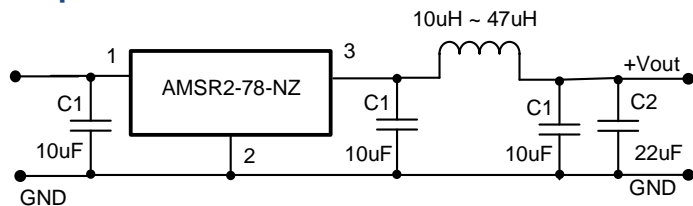

NOTE: 1. Datasheets are updated as needed and as such, specifications are subject to change without notice. Once printed or downloaded, datasheets are no longer controlled by Aimtec; refer to www.aimtec.com for the most current product specifications. 2. Product labels shown, including safety agency certifications on labels, may vary based on the date manufactured. 3. Mechanical drawings and specifications are for reference only. 4. All specifications are measured at an ambient temperature of 25°C, humidity < 75%, nominal input voltage and at rated output load unless otherwise specified. 5. Aimtec may not have conducted destructive testing or chemical analysis on all internal components and chemicals at the time of publishing this document. CAS numbers and other limited information are considered proprietary and may not be available for release. 6. This product is not designed for use in critical life support systems, equipment used in hazardous environments, nuclear control systems or other such applications which necessitate specific safety and regulatory standards other than the ones listed in this datasheet. 7. Warranty is in accordance with Aimtec's standard Terms of Sale available at www.aimtec.com.