

Wide input voltage non-isolated and regulated single output



FEATURES

- High efficiency up to 95%
- No-load input current as low as 0.2mA
- Operating ambient temperature range: -40°C to +85°C
- Support the negative output
- Output short-circuit protection
- Pin-out compatible with LM78XX linear regulators
- IEC60950, UL60950, EN62368 approved

K78xx-500R3 series are high efficiency switching regulators and ideal substitutes for LM78xx series three-terminal linear regulators. The converters feature high efficiency, low loss, short circuit protection, positive or negative output voltage, and there is no need for a heat sink. These products are widely used in applications such as industrial control, instrumentation and electric power.

Selection Guide

Certification	Part No.	Input Voltage (VDC)*		Output		Full Load Efficiency (%) Typ. Vin Min. / Vin Max.	Capacitive Load (µF) Max.
		Nominal (Range)	Voltage (VDC)	Current (mA)			
UL/CE/CB	K7803-500R3	24 (4.75-36)	3.3	500	86/80	680	
		24 (6.5-36)	5.0	500	90/84	680	
	K7805-500R3	12 (7-31)	-5.0	-300	80/81	330	
		24 (12-36)	9	500	93/90	680	
	K7812-500R3	24 (15-36)	12	500	94/91	680	
		12 (8-24)	-12	-150	84/85	330	
	K7815-500R3	24 (19-36)	15	500	95/93	680	
		12 (8-21)	-15	-150	85/87	330	

Note: * For input voltages exceeding 30 VDC, an input capacitor of 22µF/50V is required.

Input Specifications

Item	Operating Conditions	Min.	Typ.	Max.	Unit
No-load Input Current	Positive output	--	0.2	1.5	mA
Reverse Polarity at Input		Avoid / Not protected			
Input Filter		Capacitance filter			

Output Specifications

Item	Operating Conditions	Min.	Typ.	Max.	Unit	
Voltage Accuracy	Full load, input voltage range	K7803-500R3	--	±2	±4	%
		Others	--	±2	±3	
Linear Regulation	Full load, input voltage range	--	±0.2	±0.4		
Load Regulation	Nominal input voltage, 10% -100% load	3.3/5 VDC output	--	±0.6	--	
		Others	--	±0.3	--	
Ripple & Noise*	20MHz bandwidth, nominal input voltage, 10% -100% load	--	20	75	mVp-p	
Temperature Coefficient	Operating ambient temperature -40°C to +85°C	--	--	±0.03	%/°C	

Transient Response Deviation	Nominal input voltage, 25% load step change	--	50	250	mV
Transient Recovery Time		--	0.2	1	ms
Short-circuit Protection	Nominal input voltage	Continuous, self-recovery			
Notes: * ① The "parallel cable" method is used for ripple and noise test, please refer to DC-DC Converter Application Notes for specific information; ② With light loads at or below 10%, Ripple & Noise for 3.3V/5V output parts increases to 150mVp-p max, and for 9V/12V/15V output parts to 2%Vo max.					

General Specifications

Item	Operating Conditions	Min.	Typ.	Max.	Unit
Operating Temperature	See Fig. 1	-40	--	+85	°C
Storage Temperature		-55	--	+125	
Pin Soldering Resistance Temperature	Soldering spot is 1.5mm away from case for 10 seconds	--	--	+260	
Storage Humidity	Non-condensing	5	--	95	%RH
Switching Frequency	Full load, nominal input voltage	550	--	850	kHz
MTBF	MIL-HDBK-217F@25°C	2000	--	--	k hours

Mechanical Specifications

Case Material	Black plastic; flame-retardant and heat-resistant (UL94 V-0)
Dimensions	11.60 x 7.55 x 10.16 mm
Weight	1.8g (Typ.)
Cooling Method	Free air convection

Electromagnetic Compatibility (EMC)

Emissions	CE	CISPR32/EN55032	CLASS B (see Fig. 5-② for recommended circuit)	
	RE	CISPR32/EN55032	CLASS B (see Fig. 5-② for recommended circuit)	
Immunity	ESD	IEC/EN 61000-4-2	Contact ±4KV	perf. Criteria B
	RS	IEC/EN 61000-4-3	10V/m	perf. Criteria A
	EFT	IEC/EN 61000-4-4	±1KV (see Fig. 5-① for recommended circuit)	perf. Criteria B
	Surge	IEC/EN 61000-4-5	line to line ±1KV (see Fig. 5-① for recommended circuit)	perf. Criteria B
	CS	IEC/EN 61000-4-6	3Vr.m.s	perf. Criteria A

Typical Characteristic Curves

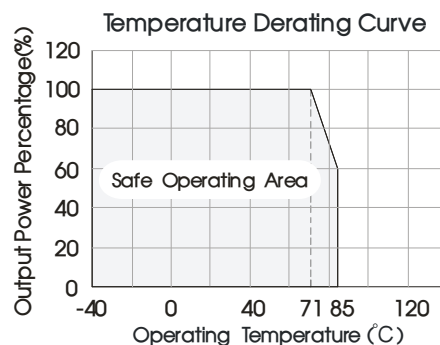
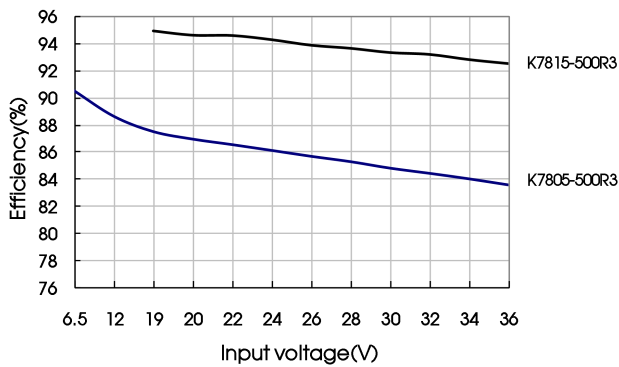
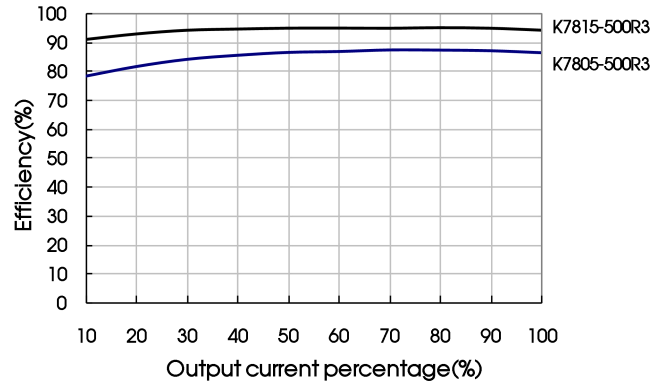

Fig. 1

Positive output efficiency Vs input voltage
(full load)



Positive output efficiency Vs output load
($V_{in}=V_{in-nominal}$)



Negative output efficiency Vs input voltage
(full load)

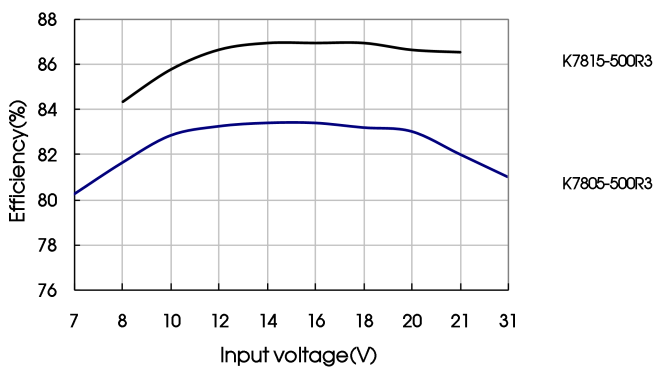

Negative output efficiency Vs output load
($V_{in}=V_{in-nominal}$)

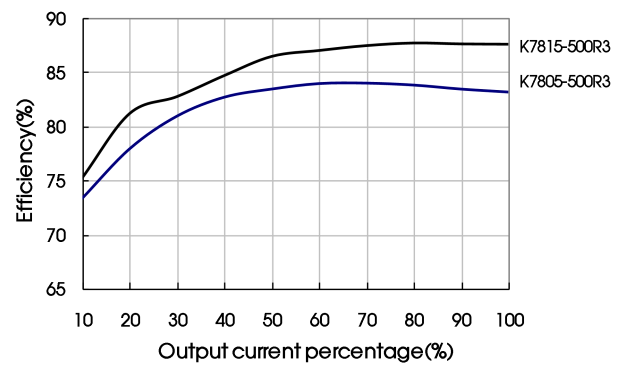

Design Reference

1. Typical application

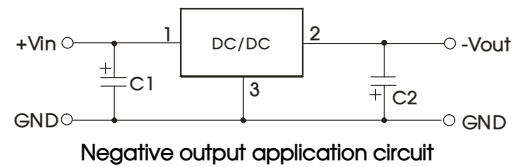
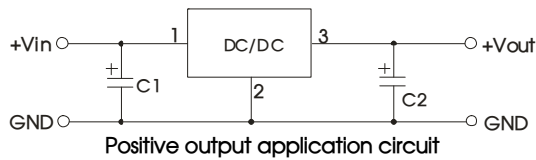
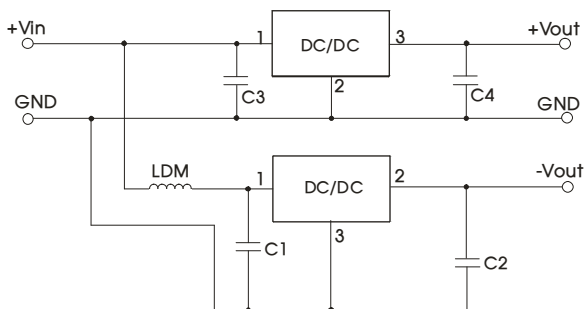

Fig. 2 Typical application circuit



Notes:

1. The required capacitors C1 and C2 (C3 and C4) must be connected as close as possible to the terminals of the module;
2. Refer to Table 1 for C1 and C2 (C3 and C4) capacitor values. For certain applications, increased values and/or tantalum or low ESR electrolytic capacitors may also be used instead;
3. When using configurations as shown in figure 3, we recommended to add an inductor (LDM) with a value of up to 10 μ H which helps reducing mutual interference;
4. Converter cannot be used for hot swap and with output in parallel;
5. To further reduce the output ripple and noise, we suggested the use of a "LC" filter at the output terminals, with an inductor value (L) of 10 μ H-47 μ H.

Table 1

Part No.	C1/C3 (ceramic capacitor)	C2/C4 (ceramic capacitor)
K7803-500R3	10 μ F/50V	22 μ F/10V
K7805-500R3		22 μ F/10V
K7809-500R3		22 μ F/16V
K7812-500R3		22 μ F/25V
K7815-500R3		22 μ F/25V

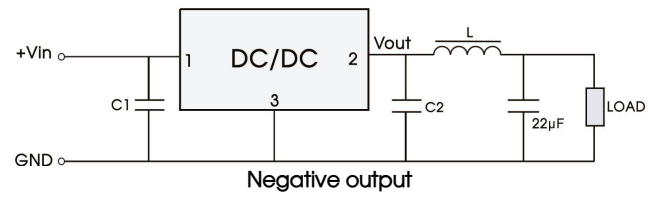
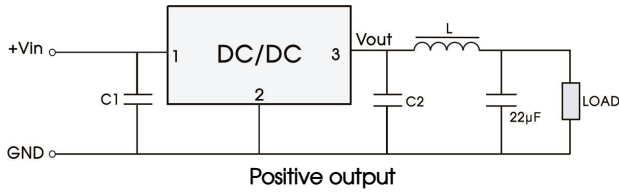

Fig. 4 Using the "LC" output filter application

2. EMC compliance circuit

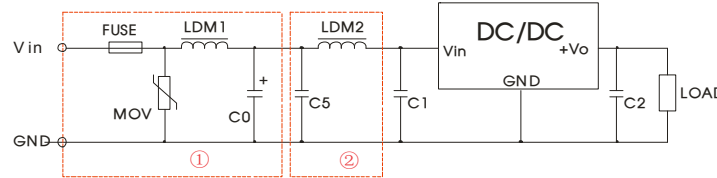

Fig. 5 EMC compliance circuit

FUSE	MOV	LDM1	C0	C1/C2	C5	LDM2
Select fuse value according to actual input current	S20K30	82µH	680µF / 50V	Refer to table 1	4.7µF / 50V	12µH

Notes: For EMC tests we use Part ① in Fig. 5 for immunity and part ② for emissions test. Selecting based on needs.

3. For additional information please refer to DC-DC converter application notes on www.mornsun-power.com

Dimensions and Recommended Layout

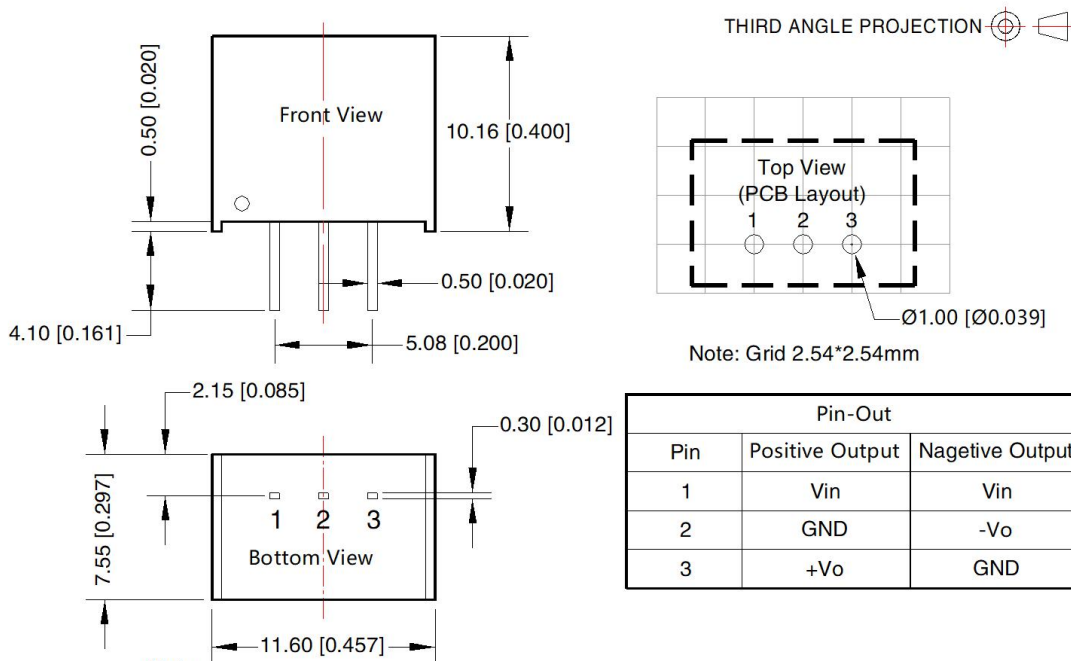

Pin-Out		
Pin	Positive Output	Negative Output
1	Vin	Vin
2	GND	-Vo
3	+Vo	GND

Note:
Unit: mm[inch]
Pin section tolerances: ± 0.10 [± 0.004]
General tolerances: ± 0.25 [± 0.010]

Notes:

1. For additional information on Product Packaging please refer to www.mornsun-power.com. Packaging bag number: 58210074;
2. The maximum capacitive load offered were tested at nominal input voltage and full load;
3. Unless otherwise specified, parameters in this datasheet were measured under the conditions of $T_a=25^{\circ}\text{C}$, humidity<75%RH with nominal input voltage and rated output load;
4. All index testing methods in this datasheet are based on our company corporate standards;
5. We can provide product customization service, please contact our technicians directly for specific information;
6. Products are related to laws and regulations: see "Features" and "EMC";
7. Our products shall be classified according to ISO14001 and related environmental laws and regulations, and shall be handled by qualified units.

MORNSUN Guangzhou Science & Technology Co., Ltd.

Address: No. 5, Kehui St. 1, Kehui Development Center, Science Ave., Guangzhou Science City, Huangpu District, Guangzhou, P. R. China
Tel: 86-20-38601850 Fax: 86-20-38601272 E-mail: info@mornsun.cn www.mornsun-power.com