

Wide input voltage non-isolated and regulated single output

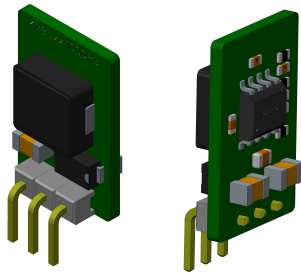

Patent Protection



Report



Report



RoHS

UL 62368-1

EN 62368-1

BS EN 62368-1

IEC 62368-1

K78Lxx-1000R3 series are high efficiency switching regulators and ideal substitutes of LM78xx series three-terminal linear regulators. The converters feature high efficiency, low loss, short circuit protection, positive or negative output voltage, and there is no need for a heat sink. These products are widely used in applications such as industrial control, instrumentation and electric power.

FEATURES

- High efficiency up to 96%
- No-load input current as low as 0.1mA
- Operating ambient temperature range: -40°C to +85°C
- Negative output available
- Output short-circuit protection
- Pin-out compatible with LM78XX linear regulators

Selection Guide

Certification	Part No.	Input Voltage (VDC)*	Output		Full Load Efficiency (%) Vin Min. / Vin Max.	Capacitive Load (µF) Max.
		Nominal (Range)	Voltage (VDC)	Current (mA) Max.		
UL/EN/BS EN/IEC	K78L03-1000R3	24 (6-36)	3.3	1000	89/80	680
	K78L05-1000R3	24 (8-36)	5	1000	93/86	680
		12 (8-27)	-5	-500	86/82	330
	K78LX6-1000R3	24 (10-36)	6.5	1000	93/87	680
	K78L12-1000R3	24 (16-36)	12	1000	95/92	680
		12 (8-20)	-12	-300	88/87	330
	K78L15-1000R3	24 (20-36)	15	1000	96/94	680
		12 (8-18)	-15	-300	89/89	330

Note: * For input voltage exceeding 30 VDC, an input electrolytic capacitor of 22µF/50V is required to prevent the module from being damaged by voltage spikes.

Input Specifications

Item	Operating Conditions	Min.	Typ.	Max.	Unit
No-load Input Current	Positive output	--	0.1	1	mA
Reverse Polarity at Input		Avoid / Not protected			
Input Filter		PI filter			

Output Specifications

Item	Operating Conditions	Min.	Typ.	Max.	Unit	
Voltage Accuracy	Full load, input voltage range	K78L03-1000R3	--	±2	±4	%
		Other output	--	±2	±3	
Linear Regulation	Full load, input voltage range	--	±0.2	±0.4		
Load Regulation	Nominal input, 10% -100% load	--	±0.4	±0.6		
Ripple & Noise ^①	20MHz bandwidth, nominal input, 20% -100% load	--	20	75	mVp-p	

Temperature Coefficient	Operating ambient temperature -40℃ to +85℃	--	--	±0.03	%/℃
Transient Response Deviation	Nominal input, 25% load step change	--	50	300	mV
Transient Recovery Time	Nominal input, 25% load step change	--	0.1	1	ms
Short-circuit Protection	Nominal input	Continuous, self-recovery			
Notes:					
① The "parallel cable" method is used for Ripple and Noise test, please refer to DC-DC Converter Application Notes for specific information;					
② With the load lower than 20%, the maximum ripple and noise of 3.3V/5V output products will be 100mVp-p, 12V/15V output products will be 2%Vo.					

General Specifications

Item	Operating Conditions	Min.	Typ.	Max.	Unit	
Operating Temperature	Derating when operating temperature $\geq 71^\circ\text{C}$ (see Fig. 1)	-40	--	85	℃	
Storage Temperature		-55	--	125		
Pin Soldering Resistance Temperature	Soldering time: 10 seconds	--	--	260		
Storage Humidity	Non-condensing	5	--	95	%RH	
Switching Frequency	Full load, nominal input	K78L03-1000R3/K78L05-1000R3	420	520	620	kHz
		/K78X6-1000R3(L)				
		Other output	580	680	780	
MTBF	MIL-HDBK-217F@25℃	2000	--	--	k hours	

Mechanical Specifications

Dimensions	11.50mm x 7.50mm x 17.50mm
Weight	2.1g (Typ.)
Cooling Method	Free air convection

Electromagnetic Compatibility (EMC)

Emissions	CE	CISPR32/EN55032	CLASS B (see Fig. 4-② for recommended circuit)	
	RE	CISPR32/EN55032	CLASS B (see Fig. 4-② for recommended circuit)	
Immunity	ESD	IEC/EN 61000-4-2	Contact $\pm 4\text{kV}$	perf. Criteria B
	RS	IEC/EN 61000-4-3	10V/m	perf. Criteria A
	EFT	IEC/EN 61000-4-4	$\pm 1\text{kV}$ (see Fig. 4-① for recommended circuit)	perf. Criteria B
	Surge	IEC/EN 61000-4-5	line to line $\pm 1\text{kV}$ (see Fig. 4-① for recommended circuit)	perf. Criteria B
	CS	IEC/EN 61000-4-6	3Vr.m.s	perf. Criteria A

Typical Characteristic Curves

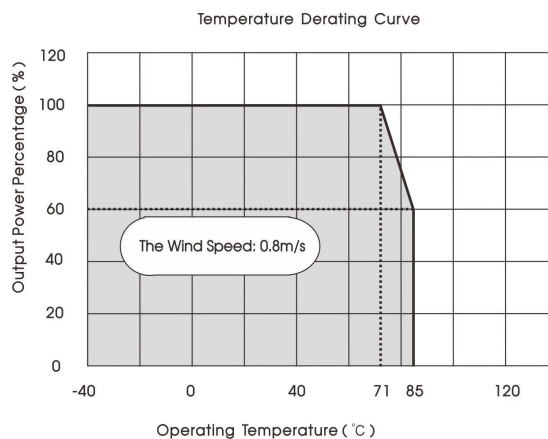
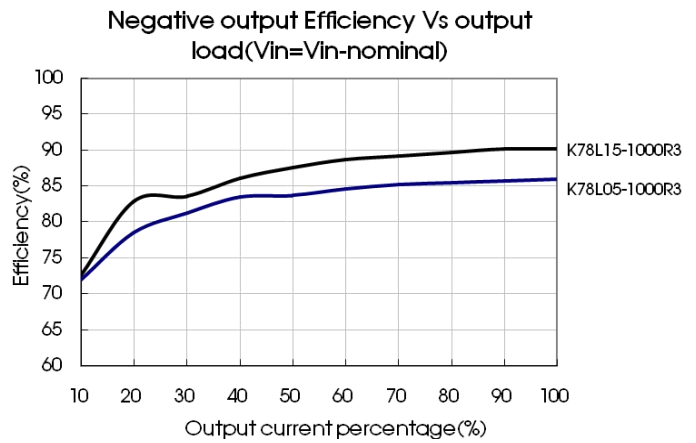
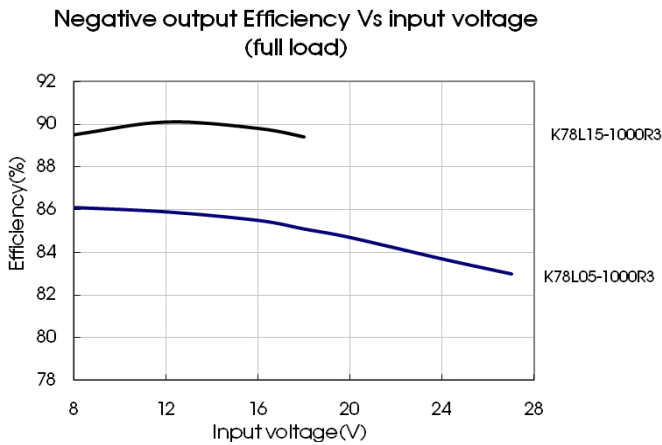
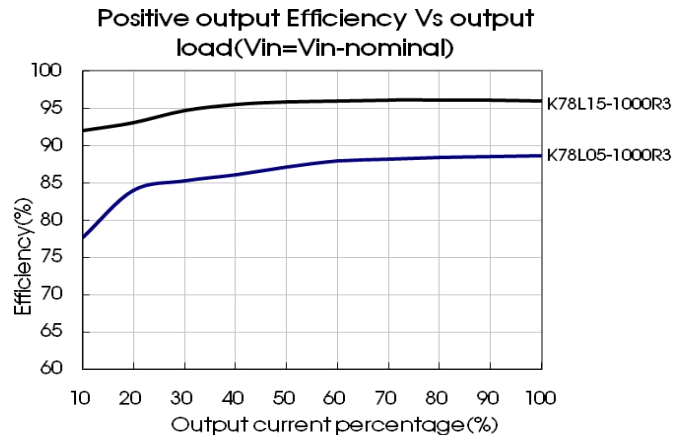
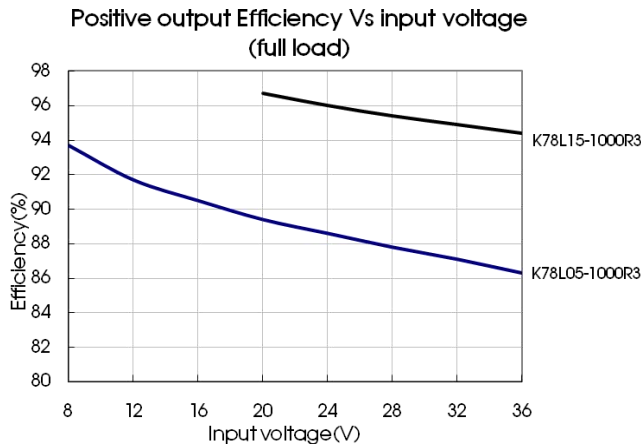

Fig. 1



Design Reference

1. Typical application

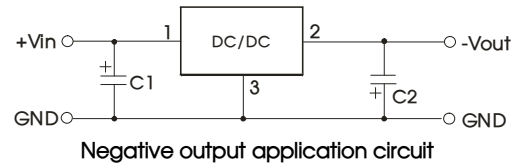
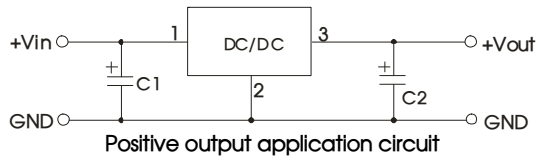

Fig. 2 Typical application circuit

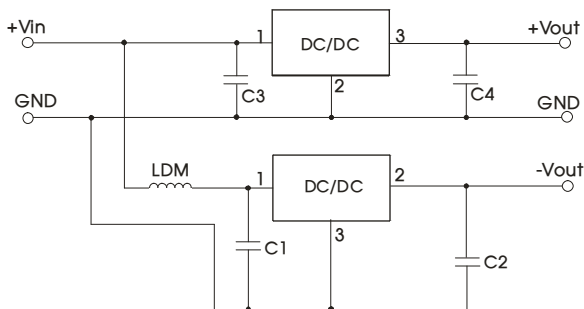

Fig. 3 Positive and negative output application circuit

Part No.	C1/C3 (ceramic capacitor)	C2/C4 (ceramic capacitor)
K78L03-1000R3	10μF/50V	22μF/10V
K78L05-1000R3		22μF/10V
K78LX6-1000R3		22μF/10V
K78L12-1000R3		22μF/25V
K78L15-1000R3		22μF/25V

Note:

1. The required C1 and C2 (C3 and C4) capacitors must be connected as close as possible to the terminals of the module;
2. Refer to Table 1 for C1 and C2 (C3 and C4) capacitor values;
3. For certain applications, increased values for C2 and C4 and/or tantalum or low ESR electrolytic capacitors may also be used instead;
4. When using configurations as shown in figure 3, we recommended to add an inductor (LDM) with a value of up to 10μH which helps reducing mutual interference;
5. Converter cannot be used for hot swap and with output in parallel.

2. EMC compliance circuit

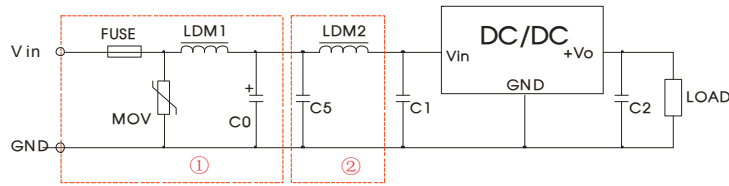

Fig.4 Recommended compliance circuit

FUSE	MOV	LDM1	C0	C1/C2	C5	LDM2
Selected fuse value according to actual input current	S20K30	82μH	680μF /50V	Refer to table 1	4.7μF /50V	12μH

Note: For EMC tests we use Part ① in Fig. 4 for immunity and part ② for emissions test. Selecting based on needs.

3. For additional information please refer to DC-DC converter application notes on www.mornsun-power.com

Dimensions and Recommended Layout

THIRD ANGLE PROJECTION

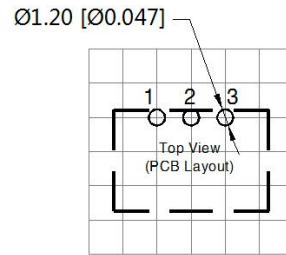
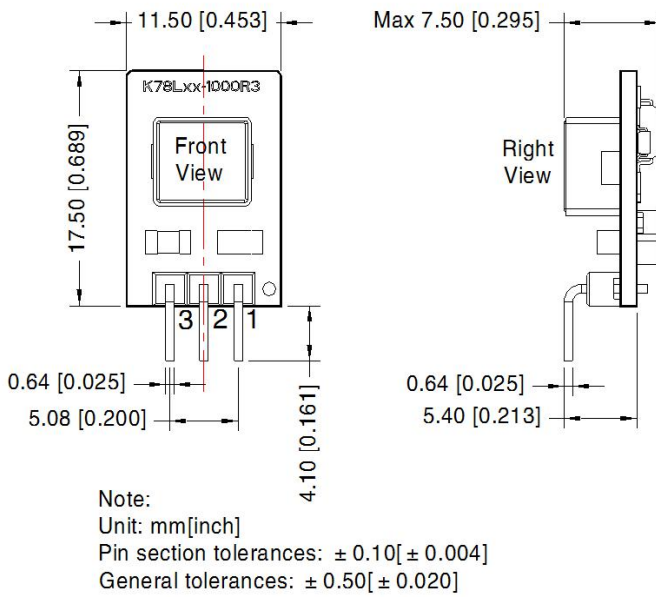

Note: Grid 2.54*2.54mm

Pin-Out		
Pin	Positive Output	Negative Output
1	Vin	Vin
2	GND	-Vo
3	+Vo	GND

Notes:

- For additional information on Product Packaging please refer to www.mornsun-power.com. Tape/Reel packaging bag number: 58210081;
- The maximum capacitive load offered were tested at nominal input voltage and full load;
- Unless otherwise specified, parameters in this datasheet were measured under the conditions of Ta=25°C, humidity<75%RH with nominal input voltage and rated output load;
- All index testing methods in this datasheet are based on our company corporate standards;
- We can provide product customization service, please contact our technicians directly for specific information;
- Products are related to laws and regulations: see "Features" and "EMC";
- Our products shall be classified according to ISO14001 and related environmental laws and regulations, and shall be handled by qualified units.

MORNSUN Guangzhou Science & Technology Co., Ltd.

Address: No. 5, Kehui St. 1, Kehui Development Center, Science Ave., Guangzhou Science City, Huangpu District, Guangzhou, P. R. China
Tel: 86-20-38601850 Fax: 86-20-38601272 E-mail: info@mornsun.cn www.mornsun-power.com