

Features

- Universal AC Input (85-264VAC)
- Protections: SCP, OVP, OLP, OTP
- DC OK Indicator LED with Relay Contacts
- 150% (180W) peak load capacity
- Built-in active PFC, PF>0,95
- High efficiency up to 92.5%

DIN Rail Series



REDIN120

120 Watt DIN-Rail Power Supply



Description

These DIN-rail mounted power supplies have a robust case, 4mm screw terminal connectors and use high reliability components to give a long, trouble-free life. The REDIN120 can be end mounted to save rail space or side mounted for use in low-profile cabinets. The units can deliver up to 150% start-up power and allow n+1 parallel operation to increase the continuous output current or for supply redundancy. Relay contacts simplify DC OK monitoring. The REDIN120 series is designed for demanding commercial and industrial applications with UL508, UL60950, IEC60950 CB report and CE (LVD + EMC + RoHS) certifications. They come with a full 5-year warranty.

Selection Guide

Part Number	nom. Input Voltage Range	Output Voltage	Output Adjustability	Rated Current	Efficiency typ. 230VAC full load
	[VAC]	[VDC]	[VDC]	[A]	[%]
REDIN120-12	100-240	12	12-14	8.33	89.5
REDIN120-24	100-240	24	24-28	5	91.5
REDIN120-48	100-240	48	48-56	2.5	92.5

Specifications (measured @ T_a= 25°C, rated Vin, rated load and after warm up)

BASIC CHARACTERISTICS

Parameter	Condition	Min.	Typ.	Max.
Input Voltage Range		85VAC		264VAC
Absolute Maximum Input Voltage	max. 3s			300VAC 375VDC
Input Current	115VAC, full load 230VAC, full load			1.5A 0.65A
Return Voltage Immunity	12Vout 24Vout 48Vout		18V 35V 65V	
Inrush Current	115VAC, cold start 230VAC, cold start		40A 60A	
No Load Power Consumption	115VAC 230VAC		1.5W 1.2W	3W 3W
Input Frequency Range		47Hz		63Hz
Output Voltage Trimming				+16.67%
Power Factor	115VAC 230VAC		0.99 0.95	
Start-up time	115VAC, full load 230VAC, full load			500ms 250ms
Hold-up time	115VAC, full load 230VAC, full load	20ms 20ms	40ms 40ms	
Ripple and Noise ⁽¹⁾	0 - 70°C -25°C	12Vout		100mVp-p 200mVp-p
	0 - 70°C -25°C	24Vout		120mVp-p 240mVp-p
	-25°C - 70°C	48Vout		240mVp-p

Notes:

Note1: Measured at 20MHz bandwidth by using a 12" twisted pair-wire terminated with a 0.1µF & 10µF parallel capacitor

continued on next page



UL60950-1 certified
UL508 certified
IEC/EN60950-1 certified

Specifications (measured @ $T_a = 25^\circ\text{C}$, rated V_{in} , rated load and after warm up)

REDIN120-12

Efficiency vs. Load

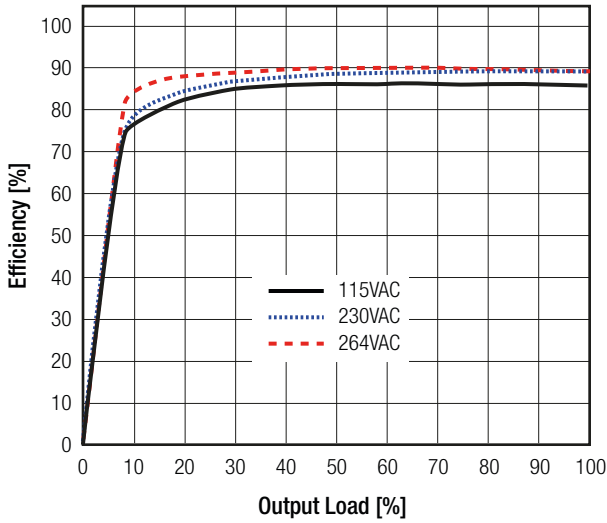

Power Dissipation vs Load

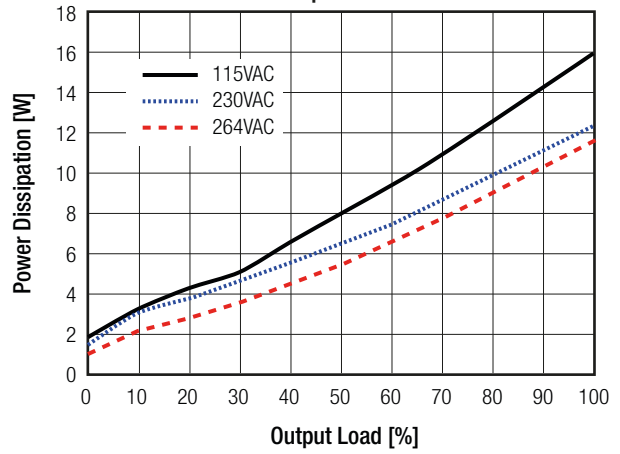

Input Current vs Load

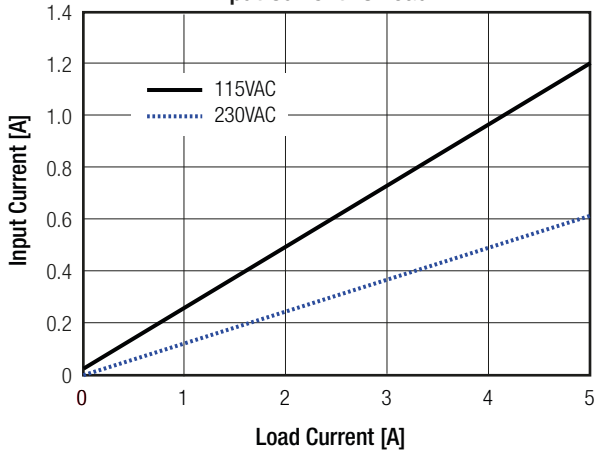

Power Factor vs Load over V_{in}

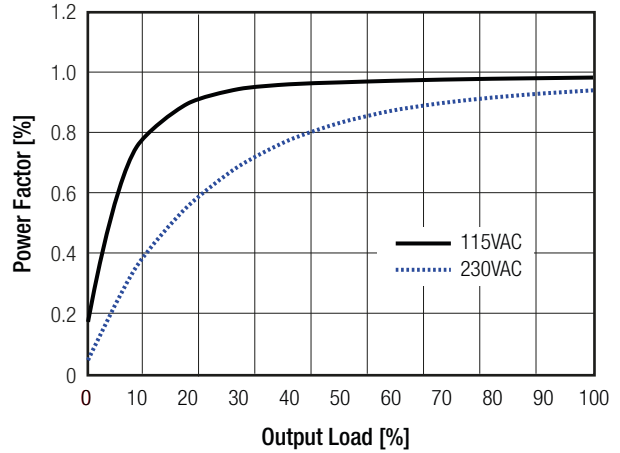

REDIN120-24

Efficiency vs. Load

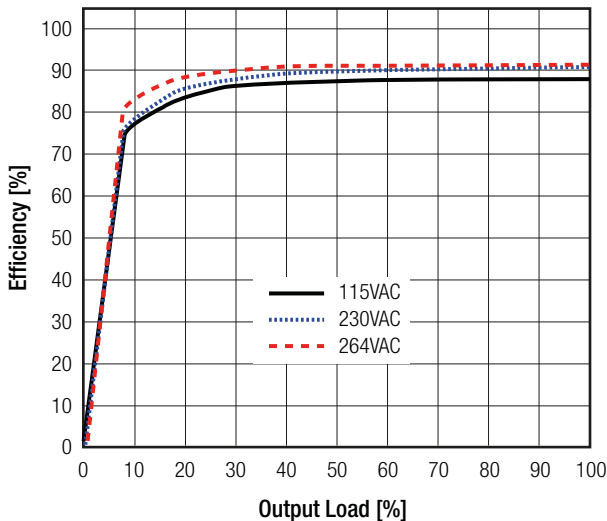

Power Dissipation vs Load

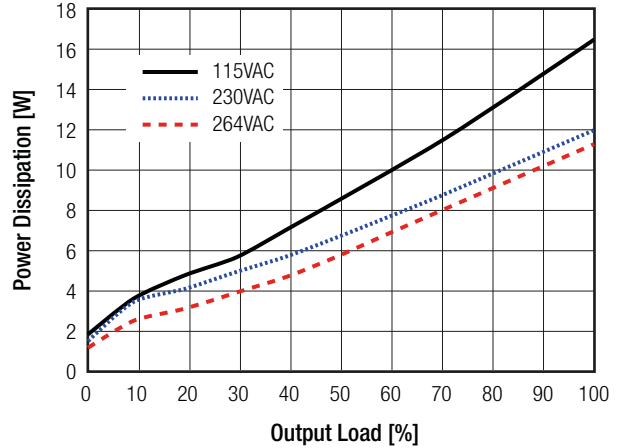

continued on next page

Specifications (measured @ $T_a = 25^\circ\text{C}$, rated V_{in} , rated load and after warm up)

REDIN120-24

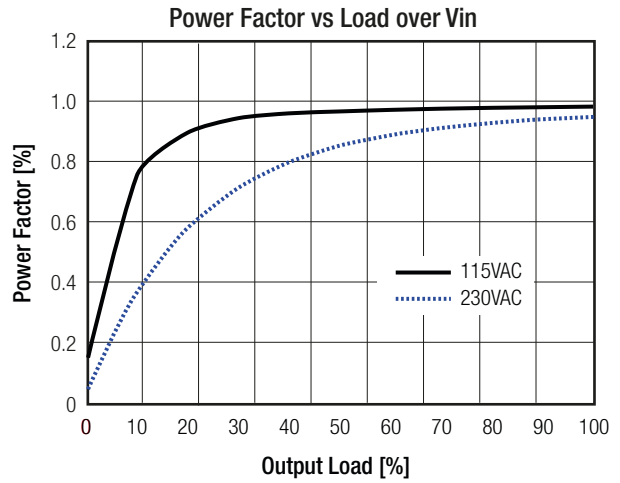
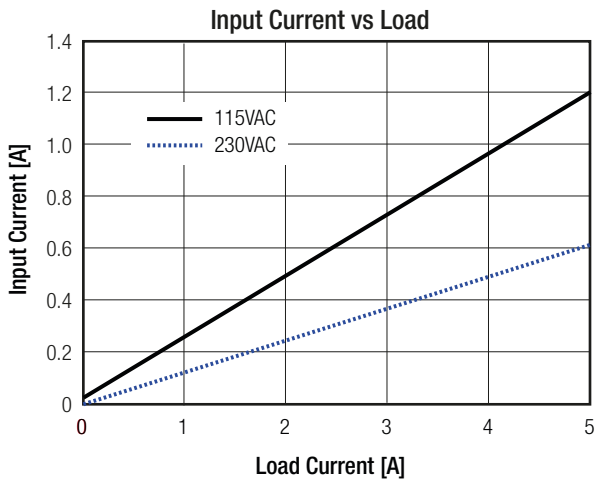

REDIN120-48

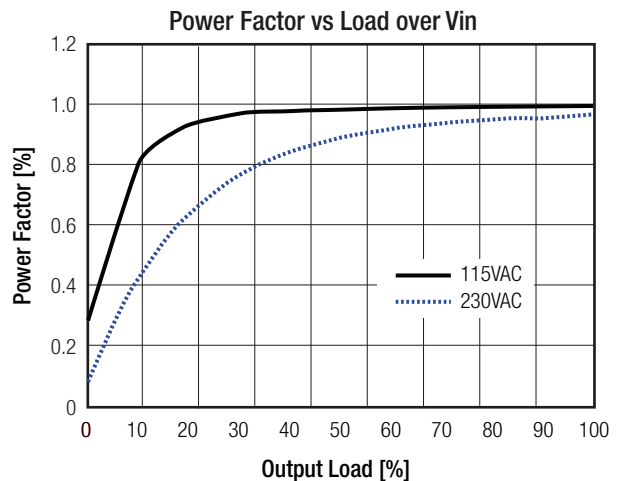
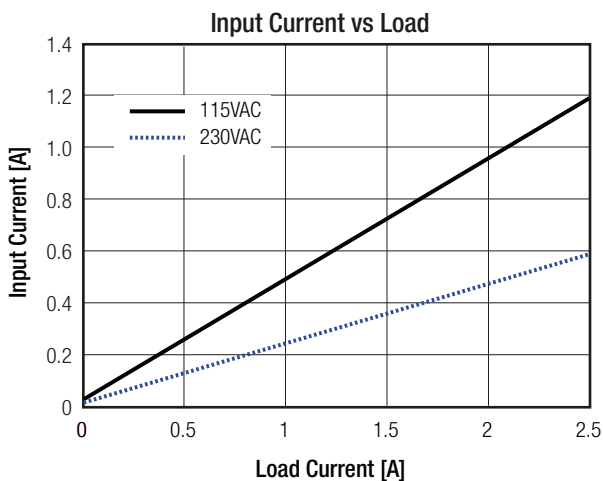
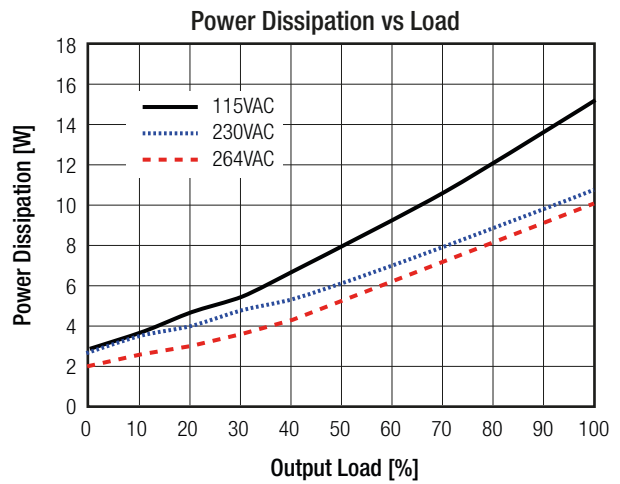
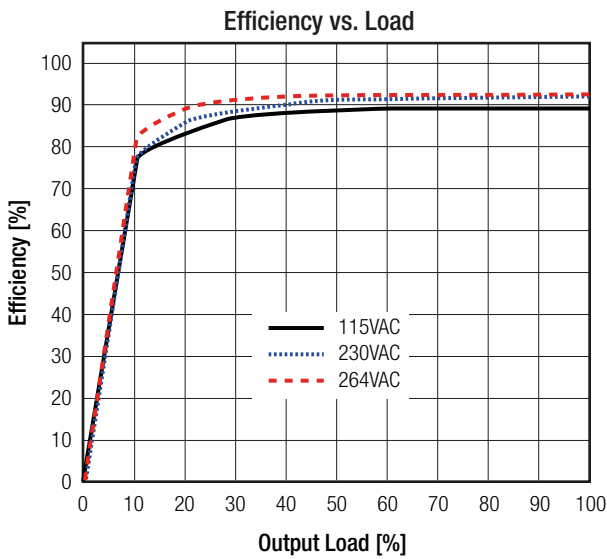

Specifications (measured @ $T_a = 25^\circ\text{C}$, rated V_{in} , rated load and after warm up)

REGULATION		
Parameter	Condition	Value
Output Accuracy		$\pm 0.25\%$ typ. / $\pm 1\%$ max.
Line Regulation		$\pm 0.1\%$ typ. / $\pm 0.5\%$ max.
Load Regulation	0% to 100% load	0.25% typ. / 1.0% max.
Transient Response	100Hz & 1kHz, 50% duty	$\pm 1\%$ typ. / $\pm 5\%$ max.

PROTECTION		
Parameter	Condition	Value
Input Fuse ⁽²⁾	internal	T5A, slow blow type
Short Circuit Protection (SCP)		hiccup mode (current limit)
Over Voltage Protection (OVP)	12Vout	15-18VDC, hiccup mode
	24Vout	29-33VDC, hiccup mode
	48Vout	58-65VDC, hiccup mode
Over Voltage Category (OVC)		OVC II
Over Load Protection (OLP)		Constant power (current limit)
Over Temperature Protection (OTP)		$100 \pm 5^\circ\text{C}$, detect on Heat-sink of power transistor; shut down O/P, auto recovery after temperature goes down
Power OK LED	ON (green)	Vout up to 90% of rated Vout
	OFF (red)	Vout down to 80% of rated Vout
Isolation Voltage	Relay Contact Rating	Max. 30V/1A or 60V/0.3 or 30VAC/0.3A Resistive Load
	I/P to O/P	3.0kVAC / 1 minute
	I/P to PE	2.5kVAC / 1 minute
Isolation Resistance	O/P to PE	0.5kVAC / 1 minute
		10M Ω min.
Leakage Current	I/P to O/P	0.1mA typ. / 0.25mA max.
	I/P to PE, 240VAC 50Hz	1.0mA max.

Notes:

Note2: Refer to local wiring regulations if input over-current protection is also required

Overload Capability

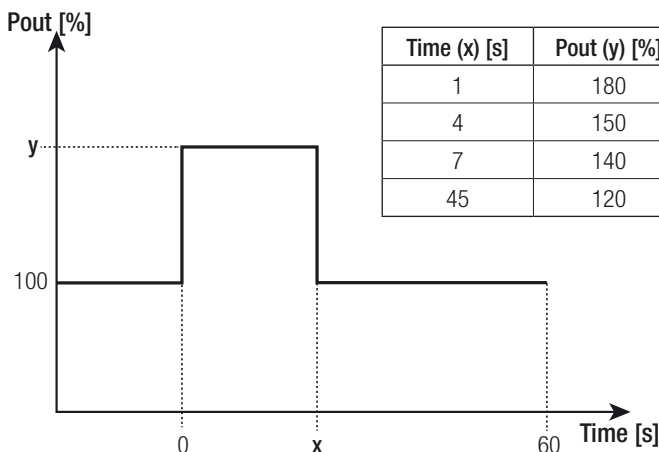

Maximum loading of automatic circuit breakers

Circuit Breaker	Circuit Breaker Current			
	Typ	Single Use	Parallel Use (2 devices)	Parallel Use (3 devices)
B		6A	6A	13A
C		10A	10A	16A

Note: Values could change depending on local mains

ENVIRONMENTAL			
Parameter	Condition	Value	
Operating Temperature Range ⁽³⁾	@ natural convection 0.1m/s	full load	-25°C to $+55^\circ\text{C}$
		refer to derating graph	-25°C to $+70^\circ\text{C}$
Temperature Coefficient		0.03%/K	
Operating Altitude ⁽⁴⁾		3000m	
Operating Humidity	non-condensing	20% - 90% RH	

continued on next page

Specifications (measured @ $T_a = 25^\circ\text{C}$, rated V_{in} , rated load and after warm up)

ENVIRONMENTAL

Parameter	Condition	Value
IP Rating		IP20
Pollution Degree (PD)		PD2
Shock		10-500Hz 2G, 60min.
Vibration		10G /11ms, along x,y and z axis
MTBF	according to MIL-HDBK-217F, full load, 25°C	300×10^3 hours

Thermal Derating

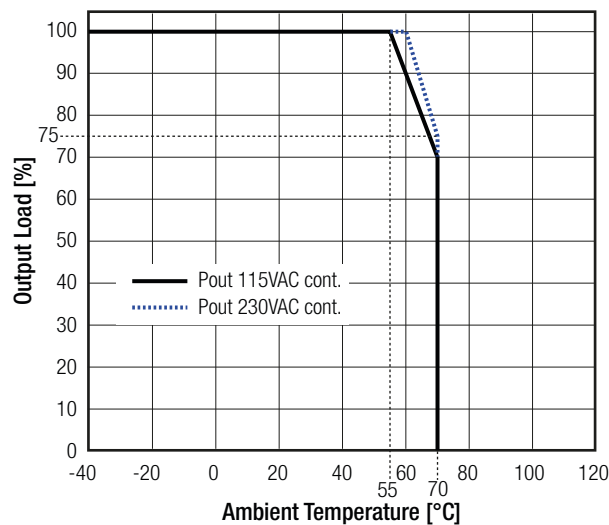

Operating Altitude

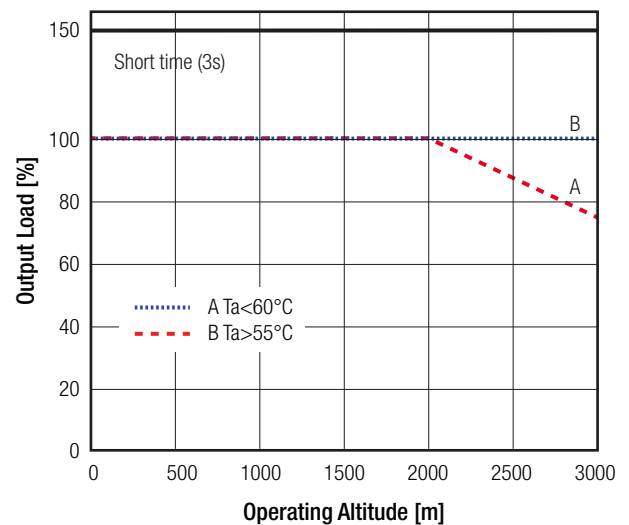

Notes:

- Note3: UL Report certified temperature range: -25°C to $+50^\circ\text{C}$. According to RECOM internal qualification the device is rated up to $+70^\circ\text{C}$ with derating
- Note4: UL Report certified operating altitude: 5000m. According to RECOM internal qualification the device is rated up to 3000m. For altitude higher than 2000m, derating 30W for every 1000m, or $5^\circ\text{C}/1000\text{m}$

SAFETY AND CERTIFICATIONS

Certificate Type	Report / File Number	Standard
Information Technology Equipment, General Requirements for Safety	E224736	UL60950-1, 2nd Edition, 2014 CSA C22.2 No. 60950-1-07, 2nd Edition, 2014
Industrial Control Equipment	E470721	UL508, 17th Edition, 2013 CSA C22.2 No. 107.1-01, 3rd Edition, 2011
Information Technology Equipment - General Requirements for Safety	SA1508106S 001 + SA1508106S 002	IEC60950-1, 2nd Edition 2005, +AM1:2009 + AM2:2013 EN60950-1:2006, + A11:2009 + A1:2010 + A12:2011 + A2:2013
EAC	RU-AT.37.02367	TP TC 004/2011
RoHs2+		RoHs 2011/65/EU

EMC Compliance

EMC Compliance	Report / Condition	Standard / Criterion
Information technology equipment - Radio disturbance characteristics - Limits and methods of measurement		EN55022, Class B, 2010
Information technology equipment - Immunity characteristics - Limits and methods of measurement		EN55024, Class B, 2010
Limitations on the amount of electromagnetic interference allowed from digital and electronic devices		47 CFR FCC Part 15, Subpart B: 2014
Methods of Measurement of Radio-Noise Emissions from Low-Voltage Electrical and Electronic Equipment in the Range of 9 kHz to 40 GHz		ANSI C63.4: 2014

continued on next page

Specifications (measured @ $T_a = 25^\circ\text{C}$, rated V_{in} , rated load and after warm up)

EMC Compliance	Report / Condition	Standard / Criterion
ESD Electrostatic discharge immunity test	Air $\pm 8\text{kV}$, Contact $\pm 4\text{kV}$	EN61000-4-2, Criteria B, 2009
Radiated, radio-frequency, electromagnetic field immunity test	3V/m	EN61000-4-3, Criteria A, 2006
Fast Transient and Burst Immunity	AC Power Port: L+N+PE $\pm 1\text{kV}$	EN61000-4-4, Criteria B, 2012
Surge Immunity	AC Power Port L-N $\pm 1\text{kV}$, L-PE + N-PE $\pm 2\text{kV}$	EN61000-4-5, Criteria B, 2014
Immunity to conducted disturbances, induced by radio-frequency fields	AC Power Port 3V	EN61000-4-6, Criteria A, 2014
Power Magnetic Field Immunity	50Hz, 1A/m	EN61000-4-8, Criteria A, 2010
Voltage Dips and Interruptions	Voltage Dips >95% Voltage Dips 30% Voltage Interruptions >95%	EN61000-4-11, Criteria B, 2004 EN61000-4-11, Criteria C, 2004 EN61000-4-11, Criteria C, 2004
Limits of Harmonic Current Emissions		EN61000-3-2, Criteria A, 2014
Voltage Fluctuations & Flicker		EN61000-3-3, Clause 5: 2013

DIMENSION and PHYSICAL CHARACTERISTICS

Parameter	Type	Value
Material	case cover	aluminium nickel plated steel
Dimension (LxWxH)	without mounting clip	114.5 x 33.0 x 124.4mm
Weight		590g typ.

Dimension Drawing (mm)

The dimension drawing shows three views of the converter:

- Front View:** Shows the top panel with terminals for DC OK (+V, -V), Vadj, DC OK LED, and AC input (N, L, PE). Dimensions include a top section height of 27.2 mm, a terminal offset of 10.3 mm, a bottom section height of 8.5 mm, and a total width of 33.0 mm.
- Top View:** Shows the overall footprint with a total length of 124.0 mm and a total width of 114.5 mm. The RECOM logo is centered. Mounting holes are spaced 55.0 mm apart, with a 28.4 mm offset from the center. The distance from the top edge to the first hole is 42.2 mm, and the distance from the bottom edge to the first hole is 56.9 mm.
- Side View:** Shows the profile of the converter with a total height of 124.4 mm and a base width of 43.0 mm.

continued on next page

Specifications (measured @ $T_a = 25^\circ\text{C}$, rated V_{in} , rated load and after warm up)

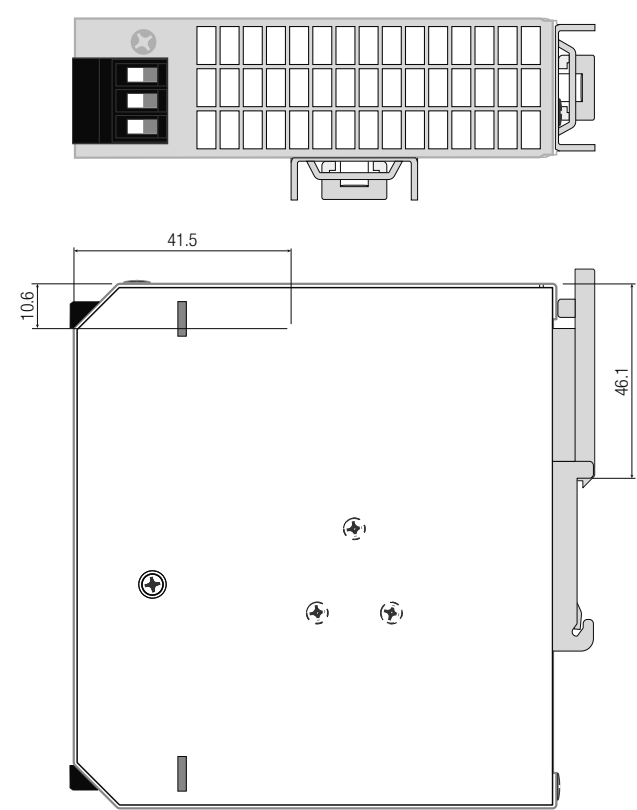

Terminals and Wiring	
Type	Screw Connector
Solid Wire	2.5-6mm ²
Stranded Wire	2.5-4mm ²
American Wire Gauge (AWG)	AWG10-16
Wire Stripping Length	8mm
Screwdriver (slotted / cross)	3.5mm
Recommended tightening torque	0.5Nm-0.8Nm
Tolerance: X.X ±0.5mm X.XX ±0.25mm	

INSTALLATION and APPLICATION

Mounting Instruction

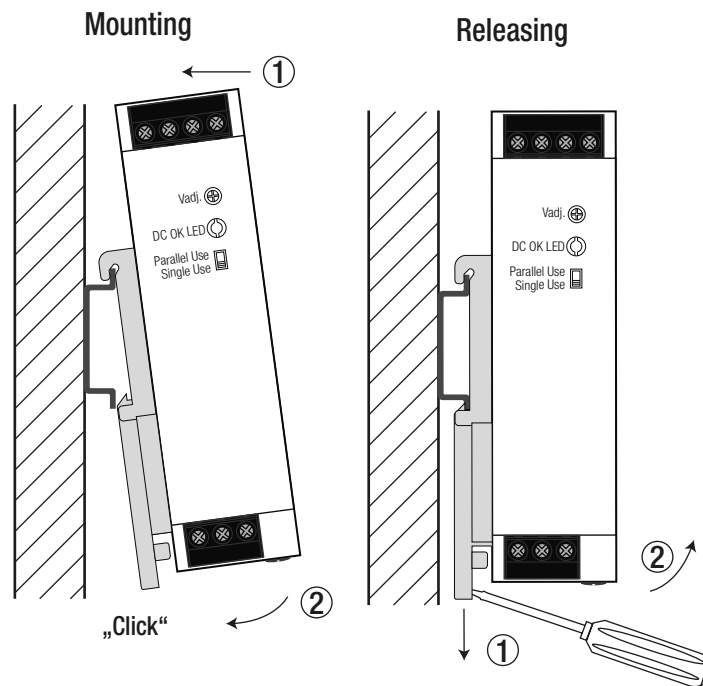

continued on next page

Specifications (measured @ $T_a = 25^\circ\text{C}$, rated V_{in} , rated load and after warm up)

INSTALLATION and APPLICATION

Mounting Multiple Power Supplies

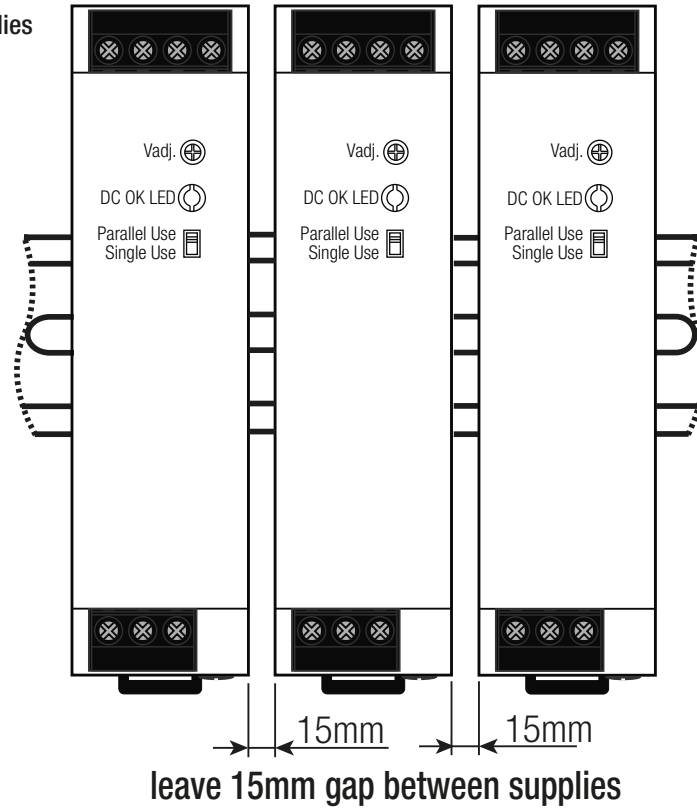

PARALLEL OPERATION

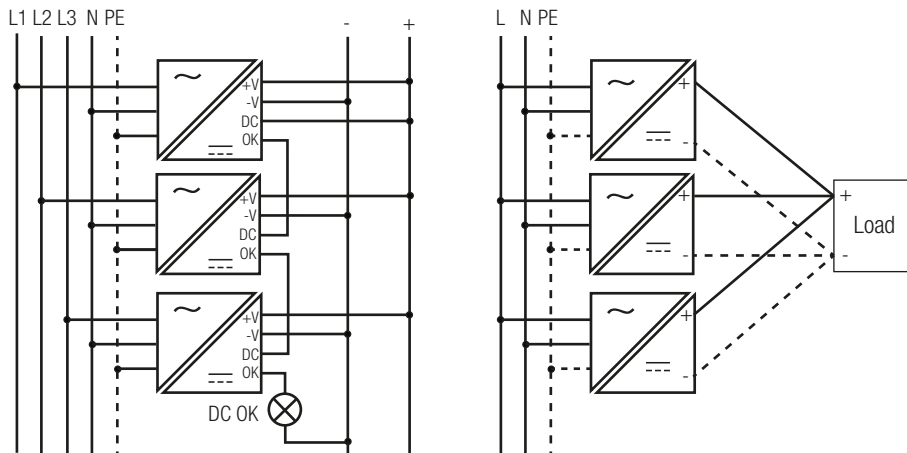

Single Operation:

- 1) Make sure that the front panel switch is set to "single Use."
- 2) The output voltage can be increased by trim pot to compensate any cable losses.

Parallel Operation:

- 1) Make sure that the front panel switch is set to "single Use" on each power supply.
- 2) Adjust each power supply to the exact same output voltage with same load and cooling conditions.
- 3) Set the front panel switches to "Parallel Use." Use the same wire length for each power supply (star connection) and energize all units at the same time to avoid triggering overload protection.

Derate the maximum output power to 90% of nominal ratings.

For operation with more than three power supplies in parallel or series operation, please contact RECOM technical support for advice.

continued on next page

Specifications (measured @ $T_a = 25^\circ\text{C}$, rated V_{in} , rated load and after warm up)

BLOCK DIAGRAMM

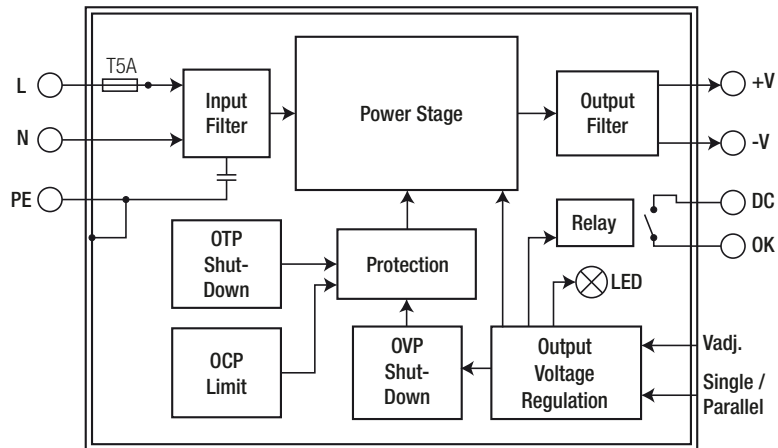

PACKAGING INFORMATION

Parameter	Type	Value
Packaging Dimension (LxWxH)	cardboard box	140.0 x 50.0 x 142.0mm
Packaging Quantity	cardboard box	1 pcs.
Storage Temperature Range		-40°C to +85°C
Storage Humidity		5% - 95% RH

The product information and specifications may be subject to changes even without prior written notice. The product has been designed for various applications; its suitability lies in the responsibility of each customer. The products are not authorized for use in safety-critical applications without RECOM's explicit written consent. A safety-critical application is an application where a failure may reasonably be expected to endanger or cause loss of life, inflict bodily harm or damage property. The applicant shall indemnify and hold harmless RECOM, its affiliated companies and its representatives against any damage claims in connection with the unauthorized use of RECOM products in such safety-critical applications.