



**Микро-Чип**  
электронные компоненты

Наличие и актуальные цены на

**AM2DS-0505S-NZ**

<https://www.icmicro.ru/store/AM2DS-0505S-NZ/>

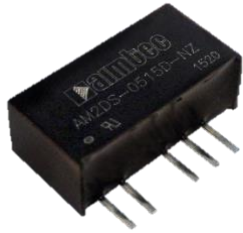

### FEATURES:

- Unregulated
- High efficiency up to 86%
- 7 pin SIP package
- Operating temperature -40°C to + 105°C
- 1500 & 3000VDC Isolation
- Continuous short circuit protection except with models marked with ‡

### Models Single output



Model	Input Voltage (V)	Output Voltage (V)	Output Current max (mA)	Isolation (VDC)	Max Cap Load (µF)	Efficiency (%)
AM2DS-0503S-NZ	4.5-5.5	3.3	400	1500	220	79
AM2DS-0505S-NZ	4.5-5.5	5	400	1500	220	84
AM2DS-0509S-NZ	4.5-5.5	9	222	1500	220	79
AM2DS-0512S-NZ	4.5-5.5	12	167	1500	220	84
AM2DS-0515S-NZ	4.5-5.5	15	133	1500	220	84
AM2DS-0524S-NZ ‡	4.5-5.5	24	83	1500	220	84
AM2DS-1203S-NZ ‡	10.8-13.2	3.3	400	1500	220	79
AM2DS-1205S-NZ ‡	10.8-13.2	5	400	1500	220	82
AM2DS-1209S-NZ ‡	10.8-13.2	9	222	1500	220	81
AM2DS-1212S-NZ ‡	10.8-13.2	12	167	1500	220	84
AM2DS-1215S-NZ ‡	10.8-13.2	15	133	1500	220	85
AM2DS-1224S-NZ ‡	10.8-13.2	24	83	1500	220	86
AM2DS-2403S-NZ ‡	21.6-26.4	3.3	400	1500	220	79
AM2DS-2405S-NZ ‡	21.6-26.4	5	400	1500	220	80
AM2DS-2412S-NZ ‡	21.6-26.4	12	167	1500	220	84
AM2DS-2415S-NZ ‡	21.6-26.4	15	133	1500	220	86
AM2DS-2424S-NZ ‡	21.6-26.4	24	83	1500	220	86
AM2DS-0505SH30-NZ	4.5-5.5	5	400	3000	220	82
AM2DS-0512SH30-NZ	4.5-5.5	12	167	3000	220	82
AM2DS-0515SH30-NZ	4.5-5.5	15	133	3000	220	83
AM2DS-0524SH30-NZ ‡	4.5-5.5	24	83	3000	220	84
AM2DS-1205SH30-NZ ‡	10.8-13.2	5	400	3000	220	82
AM2DS-1212SH30-NZ ‡	10.8-13.2	12	167	3000	220	84
AM2DS-1215SH30-NZ ‡	10.8-13.2	15	133	3000	220	85
AM2DS-2405SH30-NZ ‡	21.6-26.4	5	400	3000	220	80
AM2DS-2409SH30-NZ ‡	21.6-26.4	9	222	3000	220	86
AM2DS-2412SH30-NZ ‡	21.6-26.4	12	167	3000	220	84
AM2DS-2415SH30-NZ ‡	21.6-26.4	15	133	3000	220	86
AM2DS-2424SH30-NZ ‡	21.6-26.4	24	83	3000	220	86

### Models Dual output

Model	Input Voltage (V)	Output Voltage (V)	Output Current max (mA)	Isolation (VDC)	Max Cap Load (µF)	Efficiency (%)
AM2DS-0505D-NZ	4.5-5.5	±5	±200	1500	100	80
AM2DS-0509D-NZ	4.5-5.5	±9	±111	1500	100	84
AM2DS-0512D-NZ	4.5-5.5	±12	±83	1500	100	84
AM2DS-0515D-NZ	4.5-5.5	±15	±67	1500	100	82
AM2DS-0524D-NZ ‡	4.5-5.5	±24	±42	1500	100	84
AM2DS-1205D-NZ ‡	10.8-13.2	±5	±200	1500	100	80
AM2DS-1209D-NZ ‡	10.8-13.2	±9	±111	1500	100	82
AM2DS-1212D-NZ ‡	10.8-13.2	±12	±83	1500	100	84
AM2DS-1215D-NZ ‡	10.8-13.2	±15	±67	1500	100	84
AM2DS-1515D-NZ ‡	13.5-16.5	±15	±67	1500	100	81

AM2DS-2405D-NZ ‡	21.6-26.4	±5	±200	1500	100	80
AM2DS-2409D-NZ ‡	21.6-26.4	±9	±111	1500	100	86
AM2DS-2412D-NZ ‡	21.6-26.4	±12	±83	1500	100	84
AM2DS-2415D-NZ ‡	21.6-26.4	±15	±67	1500	100	84
AM2DS-0505DH30-NZ	4.5-5.5	±5	±200	3000	100	80
AM2DS-0509DH30-NZ	4.5-5.5	±9	±111	3000	100	84
AM2DS-0512DH30-NZ	4.5-5.5	±12	±83	3000	100	83
AM2DS-0515DH30-NZ	4.5-5.5	±15	±67	3000	100	82
AM2DS-0524DH30-NZ ‡	4.5-5.5	±24	±42	3000	100	84
AM2DS-1205DH30-NZ ‡	10.8-13.2	±5	±200	3000	100	80
AM2DS-1209DH30-NZ ‡	10.8-13.2	±9	±111	3000	100	82
AM2DS-1212DH30-NZ ‡	10.8-13.2	±12	±83	3000	100	84
AM2DS-1215DH30-NZ ‡	10.8-13.2	±15	±67	3000	100	84
AM2DS-2405DH30-NZ ‡	21.6-26.4	±5	±200	3000	100	80
AM2DS-2409DH30-NZ ‡	21.6-26.4	±9	±111	3000	100	84
AM2DS-2412DH30-NZ ‡	21.6-26.4	±12	±83	3000	100	84
AM2DS-2415DH30-NZ ‡	21.6-26.4	±15	±67	3000	100	84

‡ With Momentary short circuit protection of 1 second

NOTE: All specifications in this datasheet are measured at an ambient temperature of 25°C, humidity<75%, nominal input voltage and at rated output load unless otherwise specified.

## Input Specifications

Parameters	Nominal	Typical	Maximum	Units
Voltage range	5	4.5-5.5		VDC
	12	10.8-13.2		VDC
	15	13.5-16.5		VDC
	24	21.6-26.4		VDC
Filter	Capacitor			
Absolute Maximum Rating (1 sec. max.)	5		9	VDC
	12		18	VDC
	15		21	VDC
	24		30	VDC
Reflected Ripple Input Current			15	mA

## Isolation Specifications

Parameters	Conditions	Typical	Rated	Units
Tested I/O voltage	60 sec		1500, 3000	VDC
Resistance	500VDC	> 1000		MOhm
Capacitance	(100Khz/0.1V)	20		pF

## Output Specifications

Parameters	Conditions	Typical	Maximum	Units
Voltage accuracy	(see tolerance chart)	±5		%
Short Circuit protection	Continuous, unless marked with ‡			
Short circuit restart	Auto recovery			
Line voltage regulation	For ±1.0% change of Vin, 3.3Vout models		±1.5	% of Vin
	For ±1.0% change of Vin, Others		±1.2	% of Vin
Load voltage regulation	10~100% load, 3.3V output models	18		%
	10~100% load, 5V output models	12		%
	10~100% load, 9V output models	9		%
	10~100% load, 12V output models	8		%
	10~100% load, 15V output models	7		%
	10~100% load, 24V output models	6		%
Temperature coefficient			±0.03	%/°C
Ripple & Noise	20MHz Bandwidth	75	200	mV p-p

## General Specifications

Parameters	Conditions	Typical	Maximum	Units
Switching frequency	100% load	100		KHz
Operating temperature	Derating Above 85°C	-40 to +105		°C
Storage temperature		-55 to +125		°C
Humidity			95	% RH
Case material	Non-conductive black plastic (UL94V-0 rated)			
Weight		2.4		g
Dimensions (L x W x H)	0.77 x 0.28 x 0.40inches	19.65 x 7.05 x 10.16mm		
MTBF	>3,500,000 hrs (MIL-HDBK -217F, Ground Benign, t=+25°C)			
Maximum soldering temperature	1.5 mm from case for 10sec		300	°C
Maximum case temperature			130	°C
Cooling	Free air convection			

## Safety Specifications

Parameters	
Agency approvals	cULus (without 15V input and without 3.3V output models) UL 60950-1
Standards	EMI - Conducted and radiated emission
	Electrostatic Discharge Immunity
	CISPR32 / EN55032, class B (with the recommended EMC circuit) IEC 61000-4-2, Contact ±6KV for dual output models, Criteria B IEC 61000-4-2, Contact ±8KV for single output models, Criteria B

## Pin Out Specifications

Pin	1500 VDC		3000VDC	
	Single	Dual	Single	Dual
1	+ V Input	+ V Input	+ V Input	+ V Input
2	- V Input	- V Input	- V Input	- V Input
4	- V Output	- V Output	No pin	No pin
5	No pin	Common	- V Output	- V Output
6	+ V Output	+ V Output	No pin	Common
7	No pin	No pin	+ V Output	+ V Output

## Dimensions

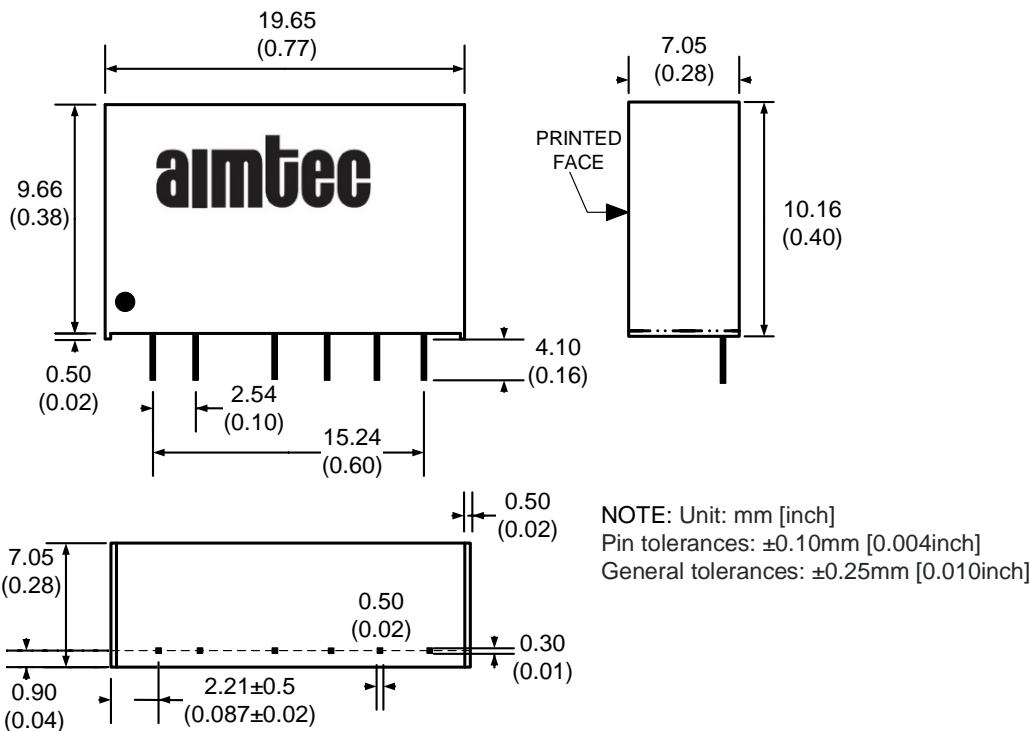

## Typical characteristics

3.3VDC output models

Tolerance Envelope Graph

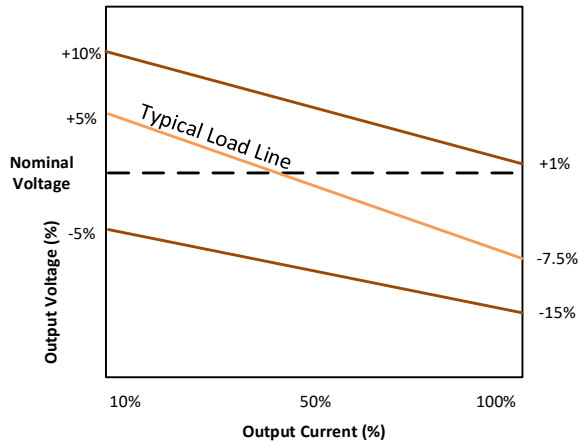

Other models

Tolerance Envelope Graph

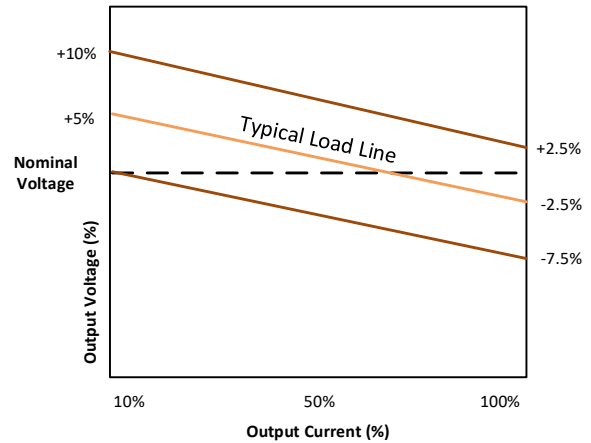

## Recommended Circuit for EMI Class B

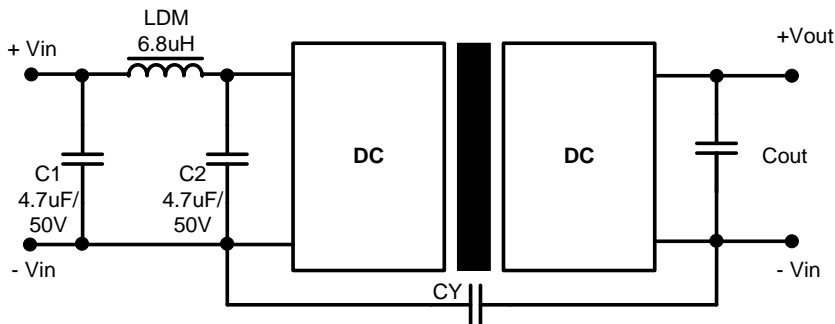

Vin	CY For 1.5KVDC isolation	CY For 3KVDC isolation	Cout
5	-	-	Refer to C2/C3 in Typical Application Circuit
9	-	-	
12	-	-	
15	-	-	
24	1nF/2KV	1nF/3KV	

## Typical Application Circuit

### Capacitor selection Table

Vin	C1	Single VDC	C2	Dual VDC	C2/C3
5	4.7μF	3.3 / 5V	10μF	±3.3 / ±5V	4.7 μF
12	2.2μF	9 / 12V	2.2μF	±9 / ±12V	1 μF
15	2.2μF	15V	1μF	±15V	0.47 μF
24	1μF	24V	1μF	±24V	0.47 μF

- 1) Ensure output load of Min 10%, or specifications may not be met
- 2) Under normal operation, there is no protection for overload condition
- 3) Converter may exhibit start up delay if capacitive load exceeds recommended
- 4) Ceramic or electrolytic type capacitors are recommended, tantalum type may damage converter
- 5) Parallel connections, or hot swapping is not recommended

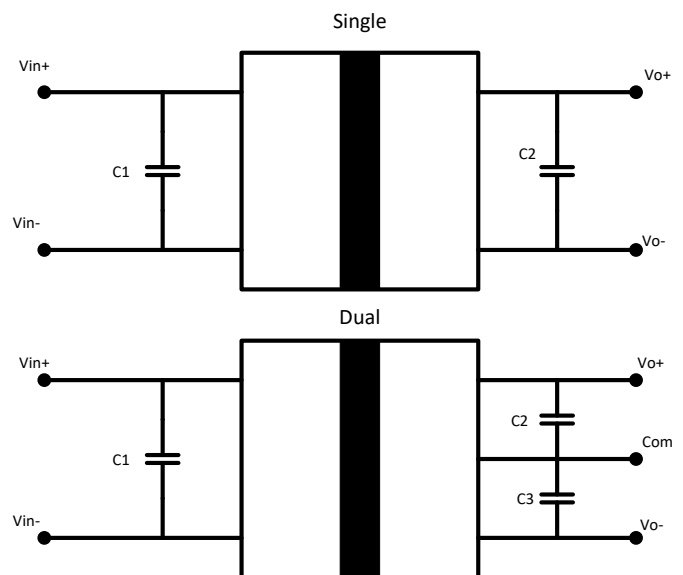

## Derating

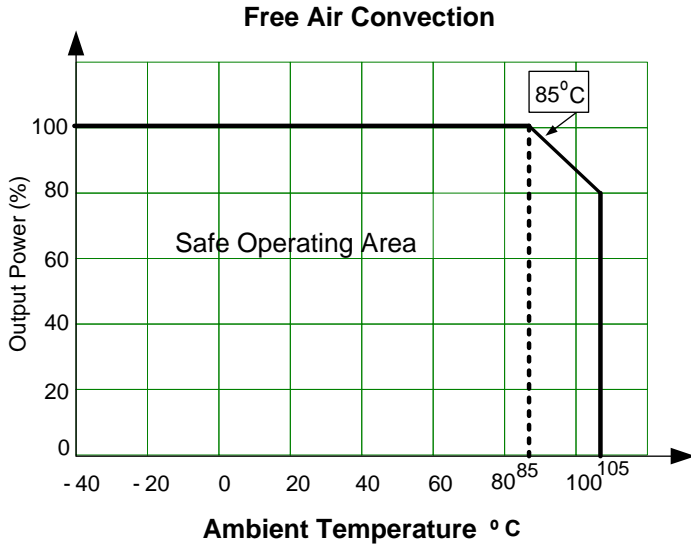

**NOTE:** **1.** Datasheets are updated as needed and as such, specifications are subject to change without notice. Once printed or downloaded, datasheets are no longer controlled by Aimtec; refer to [www.aimtec.com](http://www.aimtec.com) for the most current product specifications. **2.** Product labels shown, including safety agency certifications on labels, may vary based on the date manufactured. **3.** Mechanical drawings and specifications are for reference only. **4.** All specifications are measured at an ambient temperature of 25°C, humidity < 75%, nominal input voltage and at rated output load unless otherwise specified. **5.** Aimtec may not have conducted destructive testing or chemical analysis on all internal components and chemicals at the time of publishing this document. CAS numbers and other limited information are considered proprietary and may not be available for release. **6.** This product is not designed for use in critical life support systems, equipment used in hazardous environments, nuclear control systems or other such applications which necessitate specific safety and regulatory standards other than the ones listed in this datasheet. **7.** Warranty is in accordance with Aimtec's standard Terms of Sale available at [www.aimtec.com](http://www.aimtec.com).