

Series AMEL20-MAZ

20 Watt | AC-DC / DC-DC Converter



FEATURES:

- I/O Isolation 4000VAC
- Operating Temp: -40°C to +70°C
- Over load, Over Voltage, Short Circuit Protection
- Universal Input: 90-264VAC, 47-440Hz, or 130-170VDC
- Energy Star compliant
- Ultra-small package
- Up to 82% efficiency

Models Single output



Model	Input Voltage (VAC/Hz)	Input Voltage (VDC)	Max Output wattage (W)	Output Voltage(V)	Output Current max (A)	Maximum capacitive load (μF)	Efficiency (%)	
							115 VAC	230 VAC
AMEL20-3.3SMAZ	90-264/47-440	130-370	13.2	3.3	4	5600	74	71
AMEL20-5SMAZ	90-264/47-440	130-370	20	5	4	4700	77	77
AMEL20-12SMAZ	90-264/47-440	130-370	20	12	1.66	3300	80	79
AMEL20-15SMAZ	90-264/47-440	130-370	20	15	1.33	2200	80	81
AMEL20-24SMAZ	90-264/47-440	130-370	20	24	0.84	1000	77	79

Models Asymmetric Dual output

Model	Input Voltage (VAC/Hz)	Input Voltage (VDC)	Max Output wattage (W)	Output Voltage (V)	Rated Output Current (A)	Maximum capacitive load (μF)	Efficiency (%)	
							115 VAC	230 VAC
AMEL20-3.35DMAZ	90-264/47-440	130-370	17.5	3.3/5	1.4/2.5	1000	75	76
AMEL20-3.312DMAZ	90-264/47-440	130-370	18	3.3/12	1.4/1.1	1000	78	78
AMEL20-3.315DMAZ	90-264/47-440	130-370	18	3.3/15	1.4/0.89	1000	77	77
AMEL20-3.324DMAZ	90-264/47-440	130-370	18	3.3/24	1.4/0.55	1000	76	76
AMEL20-512DMAZ	90-264/47-440	130-370	18	5/12	1.6/0.83	680	76	77
AMEL20-515DMAZ	90-264/47-440	130-370	18	5/15	1.6/0.66	680	78	79
AMEL20-524DMAZ	90-264/47-440	130-370	18	5/24	1.6/0.46	680	75	76
AMEL20-1215DMAZ	90-264/47-440	130-370	18	12/15	0.66/0.66	560	77	78
AMEL20-1224DMAZ	90-264/47-440	130-370	18	12/24	0.58/0.42	560	79	80
AMEL20-1524DMAZ	90-264/47-440	130-370	18	15/24	0.54/0.42	560	80	81
AMEL20-3.3N5DMAZ	90-264/47-440	130-370	14.8	-3.3/5	-0.7/2.5	680	75	76
AMEL20-3.3N12DMAZ	90-264/47-440	130-370	18	-3.3/12	-1.4/1.1	680	76	77
AMEL20-3.3N15DMAZ	90-264/47-440	130-370	18	-3.3/15	-1.4/0.89	680	76	77
AMEL20-5N5DMAZ	90-264/47-440	130-370	14	-5/5	-0.8/2	680	75	76
AMEL20-5N12DMAZ	90-264/47-440	130-370	18	-5/12	-1.6/0.83	470	75	76
AMEL20-5N15DMAZ	90-264/47-440	130-370	18	-5/15	-1.6/0.66	470	75	76
AMEL20-12N12DMAZ	90-264/47-440	130-370	18	-12/12	-0.66/0.83	470	77	78
AMEL20-12N15DMAZ	90-264/47-440	130-370	18	-12/15	-0.66/0.66	330	76	77

Note: Optional mounting plate version can be ordered by adding “-ST” suffix to part number (ex. AMEL20-5SMAZ-ST)

*Output power must not exceed the listed values

NOTE: All specifications in this datasheet are measured at an ambient temperature of 25°C, humidity<75%, nominal input voltage and at rated output load unless otherwise specified.

Input Specifications

Parameters	Conditions	Typical	Maximum	Units
Current (full load)	115VAC		500	mA
	230VAC		350	mA
Inrush current <2ms (cold start)	115VAC		30	A
	230VAC		50	A

Input Specifications (continued)

Parameters	Conditions	Typical	Maximum	Units
Leakage current			0.25	mA
External fuse	Recommended slow blow type	1.5		A
Input dissipation	110/230Vac		≤1	W
Start up time		50		ms

Output Specifications

Parameters	Conditions	Typical	Maximum	Units
Voltage accuracy		±2		%
Line regulation		±1		%
Load regulation (single output)	0-100% load	±2		%
Load regulation (dual output)	Unbalanced (0-100%) load	±3		%
Transient recovery time		500		µs
Transient response deviation	25% load step	±2		% of Vout
Ripple & Noise*	3.3 & 5V models	100	150	mV p-p
	12, 15 & 24V models	150	200	
Hold-up time	110VAC	10		ms
	230VAC	25		

*Ripple and Noise are measured at 20MHz bandwidth & 230VAC by using a 0.1µF (M/C) and 47µF (E/C) parallel capacitor.

Isolation Specifications

Parameters	Conditions	Typical	Rated	Units
Tested I/O voltage	60 sec		4000	VAC
Isolation resistance		>1000		MΩ

General Specifications

Parameters	Conditions	Typical	Maximum	Units
Switching frequency		65		KHz
Over load protection	Foldback	150		%
Over voltage protection		Zener Diode Clamp		
Short circuit protection		Auto recovery		
Protection class		Class II		
Operating temperature	See derating table	-40 to +70		°C
Maximum case temperature			100	°C
Storage temperature		-45 to +95		°C
Temperature coefficient		±0.02		% / °C
Cooling		Free air convection		
Humidity	Non condensing	20 ~ 95		% RH
Case material		Plastic (flammability to UL 94V-0)		
Weight		70		g
Dimensions (L x W x H)		2.22 x 1.21 x 0.99 inches	56.48 x 30.86 x 25.10mm	
MTBF		> 400 000 hrs (MIL-HDBK -217F, t=+25°C)/Full Load > 100,000 hrs (MIL-HDBK -217F, t=at highest operating temperature)/Full Load		

Environment Approval

Test	Parameters	Conditions
Shock	Wave form	Half sine wave
	Acceleration amplitude	5gn
	Bump duration	30 ms
	Converter operation	before and after test, body mounted (on chassis)
	Number of bumps	18 (3 in each direction for every axis)
Vibration	Test mode	Sweep sine
	Displacement	1mm
	Acceleration	3g
	Converter operation	10-100Hz, speed 0.05Hz/s

Safety Specifications

Parameters		
Agency approvals	cULus, CE, CB	
Standards	Medical Electrical Equipment	IEC\EN\UL 60601-1, 2 x MOOP, CSA-C22.2 No. 601.1-M90
	Information technology Equipment	EN 60950-1:2006+A11:2009
	EMI - Conducted and radiated emission	EN55022, class B
	Harmonic Current Emissions	IEC/EN 61000-3-2, Class A
	Voltage fluctuations and flicker	IEC/EN 61000-3-3, (EN60555-3)
	Electrostatic Discharge Immunity	IEC 61000-4-2, Contact $\pm 4\text{KV}$ /Air $\pm 8\text{KV}$, Criteria A
	RF, Electromagnetic Field Immunity	IEC 61000-4-3, 3V/m, Criteria A
	Electrical Fast Transient/Burst Immunity	IEC 61000-4-4, $\pm 1\text{KV}$, Criteria A
	Surge Immunity	IEC 61000-4-5, $\pm 2\text{KV}$, Criteria A
	RF, Conducted Disturbance Immunity	IEC 61000-4-6, 3Vrms, Criteria A
	Voltage dips, Short Interruptions Immunity	IEC 61000-4-11
	Information Technology Equipment	UL 60950-1:2007
	Information Technology Equipment	CAN/CSA-C22.2 No.60950-1-07

Additional Surge Protective Circuitry

The AMEL20-MAZ series design level surge protection is certified to IEC 61000-4-5 surge Line to Line of 1KV. However greater protection can be enhanced by adding protective devices to ingress circuitry. For example, by adding an MOV (Metal Oxide Varistor) device example TVR10471KSY to the N / L input lines 2KV surge protection or greater, can be achieved.

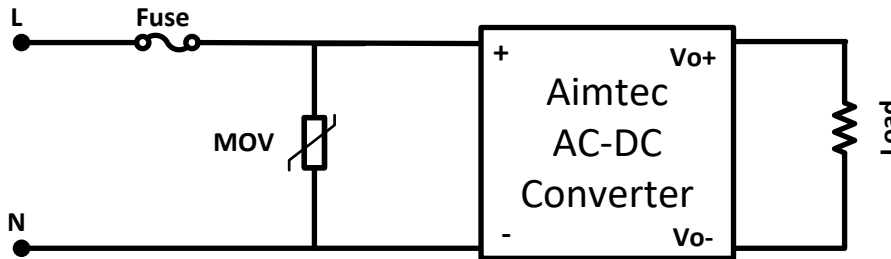

MOV PN	Vrms V	Vdc V	Wmax (2ms) J	Pmax W
TVR10471KSY	300	385	70	0.4

Pin Out Specifications

Pin	Single	Dual positive	Dual negative/positive
1	AC Input (L)	AC Input (L)	AC Input (L)
2	AC Input (N)	AC Input (N)	AC Input (N)
3	+V Output	+V1 Output	+V1 Output
4	-V Output	Common	Common
5	No pin	+V2 Output	-V2 Output

Dimensions

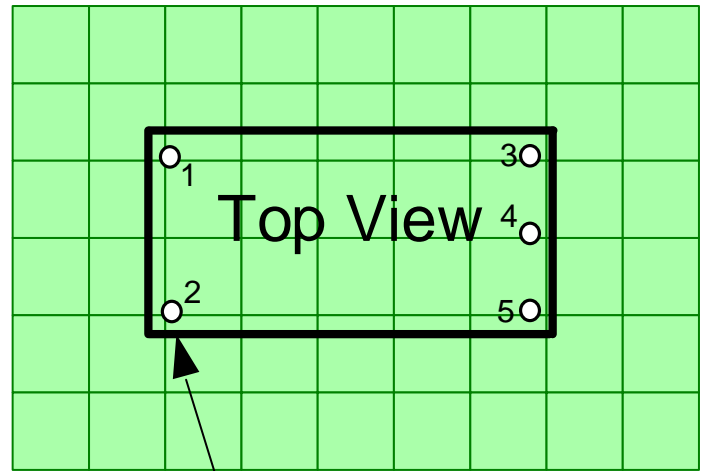
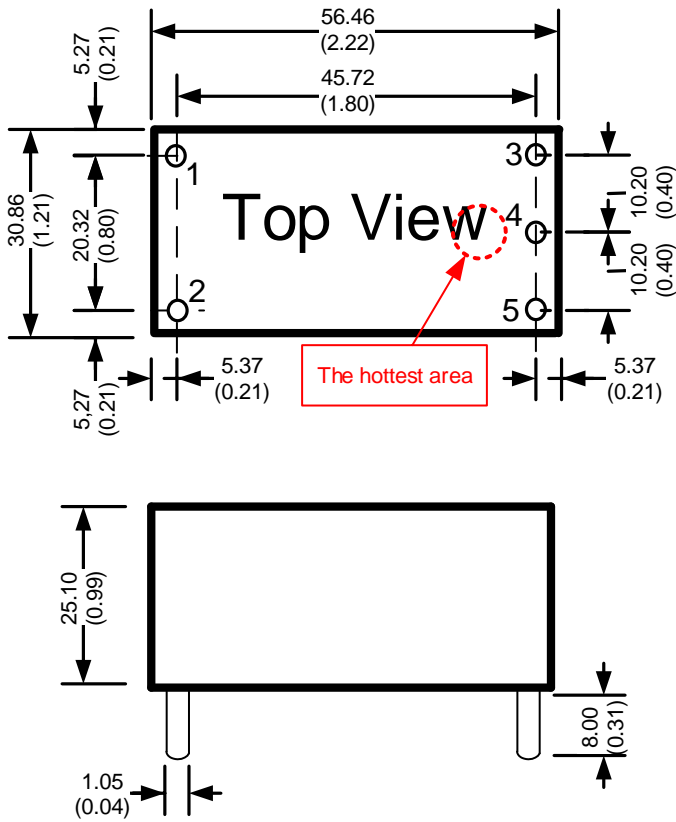

DIV: 10.00 (0.40)

5Ø 1.0 (Ø 0.04)

Dimensions mm (inch)
 Case Tolerance ± 0.50 (± 0.02)
 Pin Diameter 1.0 ± 0.05 (0.04 ± 0.002)
 Pin Pitch Tolerance ± 0.35 (± 0.014)

Derating

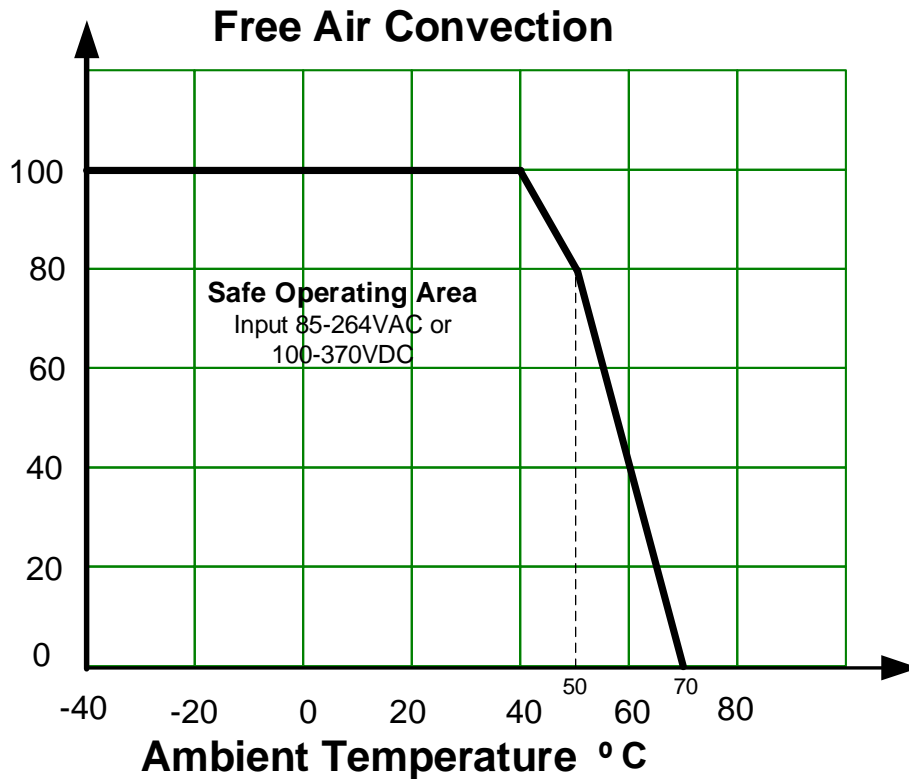

Derating (Dual Output Models)

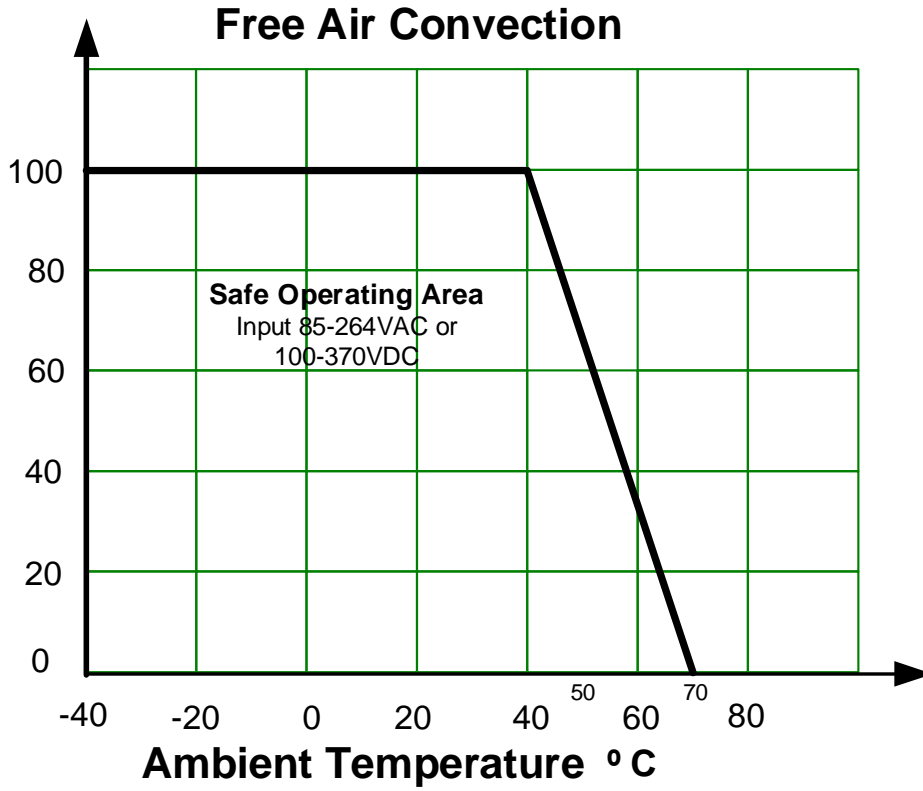

Dimensions of Optional ST Mounting Plate Version

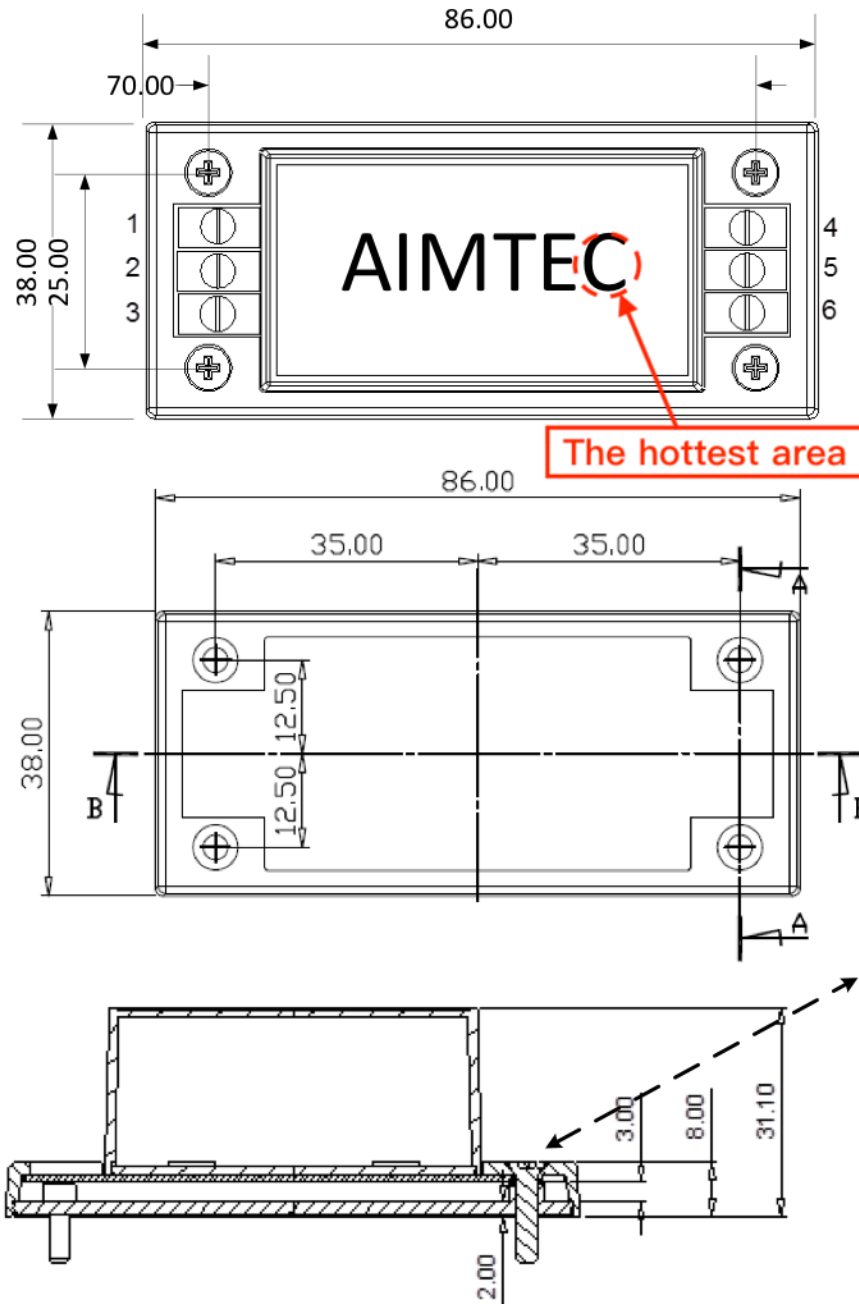

Pin Out Specification ST Version

Pin	Single	Dual positive	Dual negative / positive
1	AC Input (L)	AC Input (L)	AC Input (L)
2	No pin	No pin	No pin
3	AC Input (N)	AC Input (N)	AC Input (N)
4	+V Output	+V1 Output	+V1 Output
5	Common	Common	Common
6	No pin	+V2 Output	-V2 Output

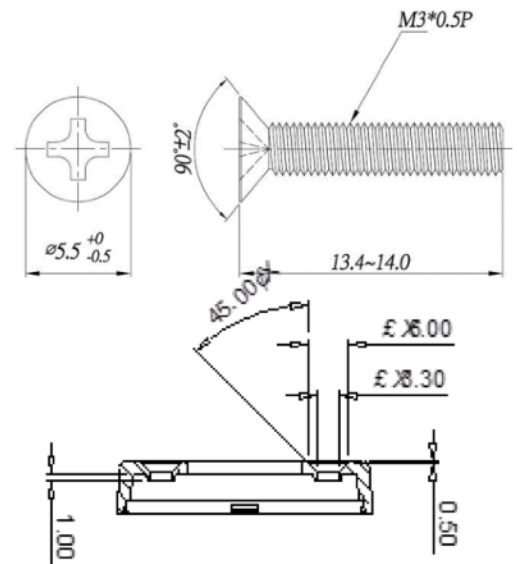

NOTE: 1. Datasheets are updated as needed and as such, specifications are subject to change without notice. Once printed or downloaded, datasheets are no longer controlled by Aimtec; refer to www.aimtec.com for the most current product specifications. 2. Product labels shown, including safety agency certifications on labels, may vary based on the date manufactured. 3. Mechanical drawings and specifications are for reference only. 4. All specifications are measured at an ambient temperature of 25°C, humidity<75%, nominal input voltage and at rated output load unless otherwise specified. 5. Aimtec may not have conducted destructive testing or chemical analysis on all internal components and chemicals at the time of publishing this document. CAS numbers and other limited information are considered proprietary and may not be available for release. 6. This product is not designed for use in critical life support systems, equipment used in hazardous environments, nuclear control systems or other such applications which necessitate specific safety and regulatory standards other the ones listed in this datasheet. 7. Warranty is in accordance with Aimtec's standard Terms of Sale available at www.aimtec.com.