

# PSRS-78xxLF



## PME02-SERIES

Rev.09-2009

- ✓ 500 mA **Switching Regulator**
- ✓ **Wide** Input
- ✓ **SMD** Plastic Package
- ✓ Non-Isolated & Regulated
- ✓ **Adjustable** Output Voltage
- ✓ SC Prot. / Thermal Shutdown
- ✓ **Remote ON/OFF** Control

The PME02-500mA Series with high efficiency switching regulators are ideally supply for space constrained mobile applications. They are no need for any heat sinks, even if operate at +85°C. The additional features include remote ON/OFF control and adjustable output voltage. Super low ripple and noise of typically only 10mV and a shutdown input current of typically only 15uA.

All specifications typical at Ta=25°C, nominal input voltage and full load unless otherwise specified

### Input Specifications

Voltage Range Wide Input (See Table)

### Output Specifications

Voltage Accuracy (100% load)	± 2%, typ.
Short Circuit Protection	Continuous (Hiccup / Automatic Recovery)
Line Regulation	± 0.2%, typ.
Load Regulation (10% - 100% load)	± 0.3%, typ.
Ripple and Noise (20Mhz bandwidth)	25 mV pk-pk, max.
Output Current Limit	1.8 A
Temperature Coefficient	± 0.02% / °C

### General Specifications

Dynamic Load Stability (100% <-> 10% load)	± 30 mV, typ.
Quiescent current (nom. Input, 3.3 and 5 Vout)	15 mA, typ
Thermal Shutdown	160°C
Capacitance Load	1000 uF, max.
ON/OFF control current ON: open or $1.5 < V_c \leq 6$ OFF: GND or $0V < V_c < 1V$	2 uA, typ.
Shutdown Input Current	30 uA, max.
ON/OFF Shutdown Threshold Voltage	1.1 V, min / 1.25 V, typ. / 1.4 V, max.
Reliability Calculated MTBF (MIL-HDBK-217F)	≥ 2 Mhrs

### Physical Specifications

Case Material	Non Conductive Black Plastic (UL94V-0 rated)
Weight	~ 2.3 g, typ.

### Environment Specifications

Operating Temperature	-40 to +85 °C (ambient)
Maximum Case Temperature	100 °C
Storage Temperature	-55 to +125 °C
Cooling	Free Air Convection (10mm distance required)

# Selection Guide

Order #	Input Voltage nom. (VDC)	Input Voltage Range (VDC)	Output Normal (VDC)	Output Adjust Range (VDC)	Current max. (mA)	Efficiency max. (%)
PSRS-783R3LF	12	4.5 - 28	3.3	1.8 - 5.5	500	90
PSRS-7805LF	12	6.0 - 28	5	2.5 - 8.0	500	94
PSRS-7812LF	24	14 - 28	12	4.5 - 13.5	500	95
PSRS-7815LF	24	17 - 28	15	4.5 - 15.5	500	96

If you need other specifications, please enquire.

**Notes:**

# Package / Pinning / Derating

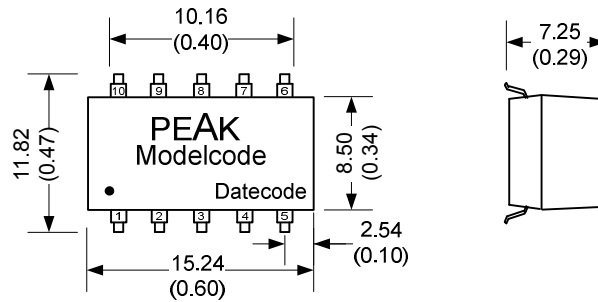

All dimensions are typical in millimeters (inches).  
 - Pin pitch tolerance: +/-0.35 (+/-0.014)  
 - Case tolerance +/-0.5 (+/-0.02)  
 Specification may change without notice.

## PME02-Series

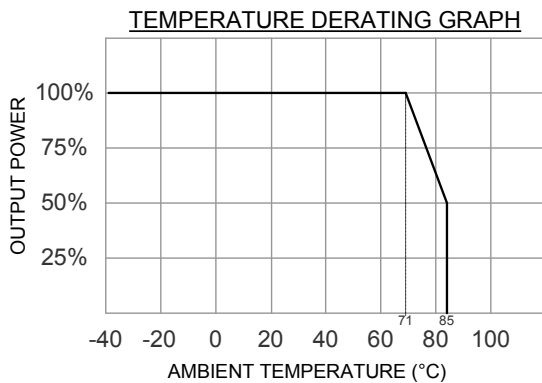

PIN CONNECTIONS	
#	Switching Reg.
1	+Vin
5	+Vout
6	Vadj
7	GND
9	GND
10	ON/OFF
others	Omitted

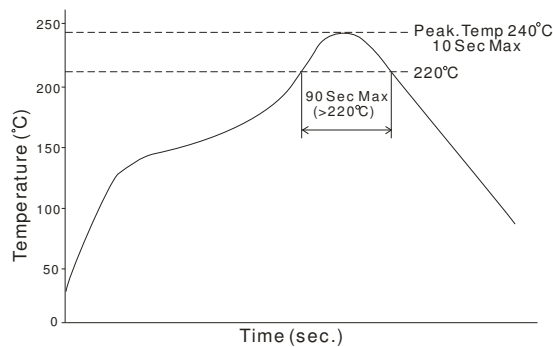

## External Capacitor Table

Part Number	C1 (ceramic cap.)	C2 (ceramic cap.)
PSRS-783R3LF	10uF/50V	22uF/16V
PSRS-7805LF	10uF/50V	22uF/16V
PSRS-7812LF	10uF/50V	10uF/25V
PSRS-7815LF	10uF/50V	10uF/25V

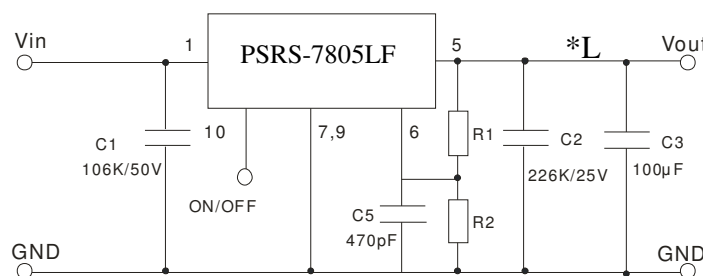

1. C1,C2: Choose a ceramic type capacitors; C3 is require ,for best performance, use a 100µF or more capacitor please.
  2. C1,C2 are require and should be placed close to the pins of the converter, with shortest possible traces.
  3. No parallel connection or plug and play.
- \*L: To reduce output ripple, it is recommended to add a LC filter to output port. Recommended parameter: 10µH ~ 47µH.

PME02-Series – PSRS-78xxLF – Switching Regulator – SMD – Plastic Case

Specification can change without a notice – We accept no liability for any inaccuracy or printing errors.

# App Notes

The ON/OFF pin provides several features for adjusting and sequencing the power supply, a user has the flexibility of using the ON/OFF pin as:

- 1) A digital on/off control by pulling down the ON/OFF pin with an open-drain transistor.

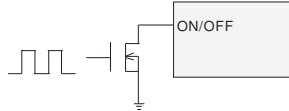

- 2) Line UVLO. If desired to achieve a UVLO voltage, an resistor divider from Vin to ON/OFF to GND can be used to disable the converter until a higher input voltage is achieved. For example, it is not useful for a converter with 12V output to start up with a 12V input voltage, as the output cannot reach regulation. To enable the converter when the input voltage reaches 14V, a 51kΩ/5kΩ resistor divider from Vin to GND can be connected to the ON/OFF pin. Both the precision 1.25V threshold and 150mV hysteresis are multiplied by the resistor ratio, providing a proportional 12% hysteresis for any startup threshold. So, the turn off threshold would be between 12.3V to 15.7V.

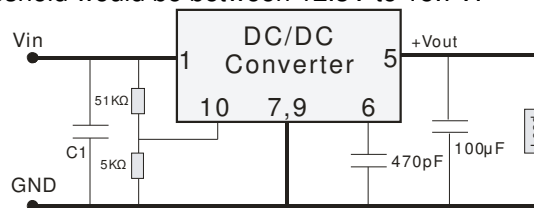

- 2) Power supply sequencing. By connecting a small capacitor from ON/OFF to GND, the 2µA current source and 1.25V threshold can provide a stable and predictable delay between start-up of multiple power supplies. For example, a start-up delay of roughly 64mS is provided using 100nF, and roughly 136mS by using 200nF.

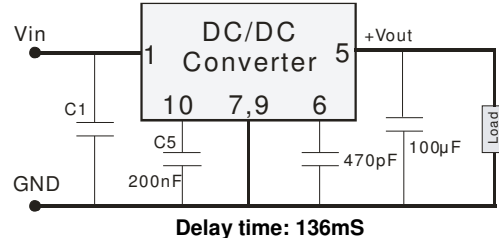
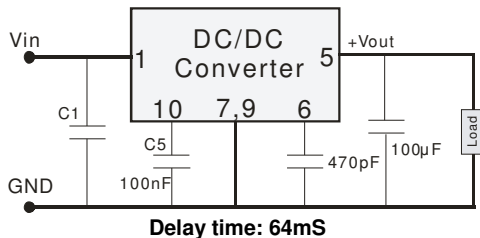

Part #	Vout (nominal)	Vout adjust up R2 (kOhm)	Vout adjust down R1 (kOhm)
PSRS-783R3LF	3.3	$= \frac{75.10 - 10 * Vout}{Vout - 3.3}$	$= \frac{61 * Vout - 75.10}{3.3 - Vout}$
PSRS-7805LF	5	$= \frac{91.52 - 10 * Vout}{Vout - 5}$	$= \frac{61 * Vout - 91.52}{5 - Vout}$
PSRS-7812LF	12	$= \frac{287.02 - 20 * Vout}{Vout - 12}$	$= \frac{71 * Vout - 287.02}{12 - Vout}$
PSRS-7815LF	15	$= \frac{269.37 - 15 * Vout}{Vout - 15}$	$= \frac{66 * Vout - 269.37}{15 - Vout}$

The R1, R2 which choose from the table 1 equation are used to set the output voltage. Select the R1 or R2 resistor to provide the desired regulation voltage. R1 is used to set the output voltage to lower, R2 is used to set the output voltage to higher. If no need to adjust the output voltage, please connect a ceramic capacitor to GND with 470pF typical value. Insure the output voltage is in the adjust range.