

# WDD30U SERIES

DC - DC CONVERTER  
23 ~ 30W SINGLE & DUAL OUTPUT



## FEATURES

- EFFICIENCY UP TO 89%
- 2:1 WIDE INPUT RANGE
- I/O ISOLATION
- INPUT Pi FILTER
- SHORT CIRCUIT PROTECTION
- HIGH PERFORMANCE
- 3 YEARS WARRANTY



## MODEL LIST

MODEL NO.	INPUT VOLTAGE	INPUT CURRENT (typ.)   (max.)		OUTPUT WATTAGE	OUTPUT VOLTAGE	OUTPUT CURRENT	EFF. (min.)	EFF. (typ.)	CAPACITOR LOAD (max.)
<b>Single Output Models</b>									
WDD30 - 03S1U	9~18 VDC	2.4 A	3.3 A	23 WATTS	+3.3 VDC	7000 mA	79%	81%	7000 $\mu$ F
WDD30 - 05S1U	9~18 VDC	2.5 A	3.35 A	25 WATTS	+ 5 VDC	5000 mA	83%	85%	7000 $\mu$ F
WDD30 - 12S1U	9~18 VDC	3.0 A	4.1 A	30 WATTS	+ 12 VDC	2500 mA	82%	84%	1000 $\mu$ F
WDD30 - 15S1U	9~18 VDC	2.97 A	4.1 A	30 WATTS	+ 15 VDC	2000 mA	83%	85%	470 $\mu$ F
WDD30 - 03S2U	18~36 VDC	1.19 A	1.62 A	23 WATTS	+3.3 VDC	7000 mA	80%	82%	7000 $\mu$ F
WDD30 - 05S2U	18~36 VDC	1.22 A	1.66 A	25 WATTS	+ 5 VDC	5000 mA	84%	86%	7000 $\mu$ F
WDD30 - 12S2U	18~36 VDC	1.42 A	1.95 A	30 WATTS	+ 12 VDC	2500 mA	86%	88%	1000 $\mu$ F
WDD30 - 15S2U	18~36 VDC	1.42 A	1.95 A	30 WATTS	+ 15 VDC	2000 mA	87%	89%	470 $\mu$ F
WDD30 - 03S3U	35~75 VDC	0.59 A	0.82 A	23 WATTS	+3.3 VDC	7000 mA	81%	83%	7000 $\mu$ F
WDD30 - 05S3U	35~75 VDC	0.6 A	0.82 A	25 WATTS	+ 5 VDC	5000 mA	82%	84%	7000 $\mu$ F
WDD30 - 12S3U	35~75 VDC	0.71 A	1.0 A	30 WATTS	+ 12 VDC	2500 mA	86%	88%	1000 $\mu$ F
WDD30 - 15S3U	35~75 VDC	0.7 A	1.0 A	30 WATTS	+ 15 VDC	2000 mA	87%	89%	470 $\mu$ F
<b>Dual Output Models</b>									
WDD30 - 05D1U	9~18 VDC	2.51 A	3.4 A	25 WATTS	$\pm$ 5 VDC	$\pm$ 2500 mA	82%	84%	$\pm$ 3500 $\mu$ F
WDD30 - 12D1U	9~18 VDC	2.95 A	4.1 A	30 WATTS	$\pm$ 12 VDC	$\pm$ 1250 mA	83%	85%	$\pm$ 470 $\mu$ F
WDD30 - 15D1U	9~18 VDC	2.94 A	4.0 A	30 WATTS	$\pm$ 15 VDC	$\pm$ 1000 mA	84%	86%	$\pm$ 470 $\mu$ F
WDD30 - 05D2U	18~36 VDC	1.24 A	1.7 A	25 WATTS	$\pm$ 5 VDC	$\pm$ 2500 mA	83%	85%	$\pm$ 3500 $\mu$ F
WDD30 - 12D2U	18~36 VDC	1.41 A	1.95 A	30 WATTS	$\pm$ 12 VDC	$\pm$ 1250 mA	86%	88%	$\pm$ 470 $\mu$ F
WDD30 - 15D2U	18~36 VDC	1.42 A	1.95 A	30 WATTS	$\pm$ 15 VDC	$\pm$ 1000 mA	87%	89%	$\pm$ 470 $\mu$ F
WDD30 - 05D3U	35~75 VDC	0.62 A	0.88 A	25 WATTS	$\pm$ 5 VDC	$\pm$ 2500 mA	83%	85%	$\pm$ 3500 $\mu$ F
WDD30 - 12D3U	35~75 VDC	0.7 A	1.0 A	30 WATTS	$\pm$ 12 VDC	$\pm$ 1250 mA	86%	88%	$\pm$ 470 $\mu$ F
WDD30 - 15D3U	35~75 VDC	0.71 A	1.0 A	30 WATTS	$\pm$ 15 VDC	$\pm$ 1000 mA	87%	89%	$\pm$ 470 $\mu$ F

### SPECIFICATION

All Specifications Typical At Nominal Line, Full Load, 25°C Unless Otherwise Noticed

#### GENERAL

Characteristics	Conditions	min.	typ.	max.	unit
Switching frequency	Vi nom, Io nom		250		KHz
Isolation voltage	Input - Output	1,500			VDC
Isolation resistance	Input - Output, @ 500VDC	100			MΩ
Isolation capacitance	100KHz / 1V			1,000	PF
Ambient temperature	Vi nom, 3.3V & 5V output models	-40		+ 61	°C
	Io nom 12V, 15V & dual output models	-40		+ 71	°C
Case temperature	Operating at Vi nom, Io nom			+ 100	°C
Derating	Vi nom	See derating curve			
Storage temperature	Non operational	-40		+ 100	°C
Relative humidity	Vi nom, Io nom	20		95	% RH
Temperature coefficient	Vi nom, Io min			± 0.02	% / °C
Dimension		L50.8 x W40.64 x H10.16			mm
MTBF	Belcore issue 6@40°C, GB		7,480,000		Hours
Cooling	Free air convection				

#### INPUT SPECIFICATIONS

Characteristics	Conditions	min.	typ.	max.	unit
Input voltage range	Ta min ... Ta max, Io nom	9	12	18	VDC
		18	24	36	VDC
		35	48	75	VDC
No load input current	Vi nom, Io=0	12V		25	mA
		24V		20	mA
		48V		15	mA
Input voltage w/o damage	Io nom	12V		20	VDC
		24V		40	VDC
		48V		80	VDC
Startup voltage	Io nom	12V	8.5		VDC
		24V	16		VDC
		48V	33		VDC
Input filter	Pi type				

#### OUTPUT SPECIFICATIONS

Characteristics	Conditions	min.	typ.	max.	unit
Output voltage accuracy	Vi nom, Io nom			± 2	%
Minimum load	Vi nom single output models	0			%
	dual output models (each output)	10			%
Line regulation	Io nom, Vi min ... Vi max			± 1	%
Load regulation	Vi nom, Io 0 ... Io nom, single output models			± 2	%
	Vi nom, Io min ... Io nom, dual output models			± 5	%
Cross regulation (Dual model)	Aymmetrical load 10% - 100% FL			± 5	%
Startup time	Vi nom, Io nom			30	ms
Transient recovery time	Vi nom, I ~ 0.5 Io nom			500	μs
Ripple & noise	Vi nom, Io nom, 3.3V & 5V models			100	mV
	BW = 20MHz 12V, 15V & dual			150	mV
Voltage trim range (I)	Vi nom	3.3V model	± 5		%
		5V, 12V, 15V & dual	± 10		%
Efficiency	Vi nom, Io nom, Po / Pi	Up to 89%, See model list and efficiency curve			

NOTE 1 : Pls refer to Fig 1 & Table 1 for connection and resistance recommended.

### SPECIFICATION

All Specifications Typical At Nominal Line, Full Load, 25°C Unless Otherwise Noticed

### CONTROL AND PROTECTION

Remote ON / OFF	ON : opened or 8 ~ 10VDC applied, reference to input GND OFF : -0.3 ~ 2VDC applied, reference to input GND
Input reversed	Shunt diode built in, external fuse recommended (12Vin : 5A, 24Vin : 2A, 48Vin : 1.25A)
Output short circuit	Current limited (Auto-recovery)
Rated over load protection	110%min....140%max

### APPROVALS AND STANDARD

UL/cUL	UL 60950-1 Recognized
cTUVus	UL 62368-1
TUV	EN 62368-1
CE	EN 61204-3, EN 55032, Class A, EN 61000-4-2, EN61000-4-3, EN61000-4-4, EN61000-4-6
Vibration	meet IEC 60068-2-6 (10-500 Hz, 2G, along X, Y, Z each Axis, 60 min for each Axis)

### PHYSICAL CHARACTERISTICS

Case size	50.8 x 40.64 x 10.16 mm (2 x 1.6 x 0.4 inches)
Case material	Plastic base / Metal case
Weight	60 g
Potting material	Silicone

### MECHANISM & PIN CONFIGURATION

mm [inch]

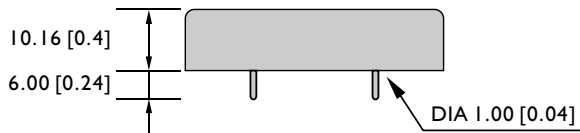

GENERAL TOLERANCE	
0.00[0.00] - 30.00[1.18]	±0.30[0.01]
30.00[1.18] - 120.00[4.72]	±0.50[0.02]

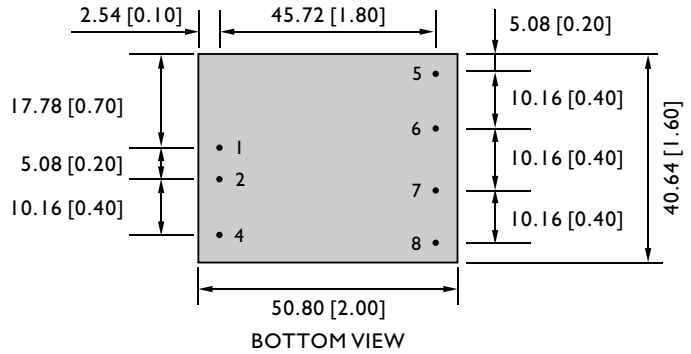

### PIN ASSIGNMENT

#### GENERAL

PIN NO.	1	2	4	5	6	7	8
SINGLE	Vi +	Vi -	ON / OFF	NO PIN	Vo +	Vo -	Trim
DUAL	Vi +	Vi -	ON / OFF	Vo +	com	Vo -	Trim

### CIRCUIT SCHEMATIC

• Block diagram for WDD30U series with single output

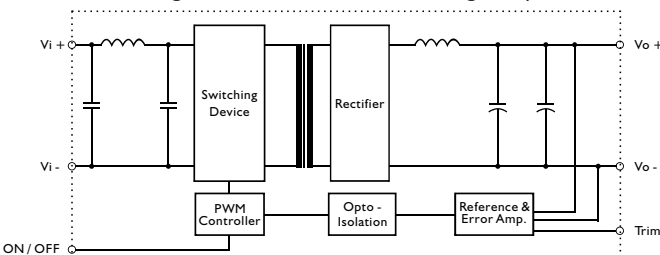

• Block diagram for WDD30U series with dual output

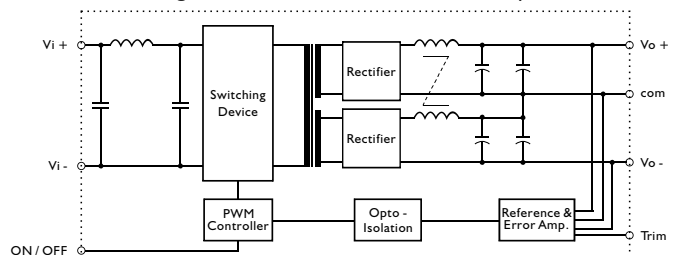

### RECOMMENDED CIRCUIT

• Recommended filter for EN 55032 Class B compliance

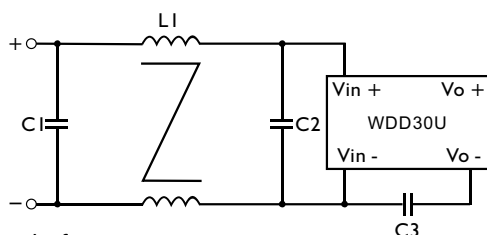

• Recommended EN 55032 Class B filter circuit layout.

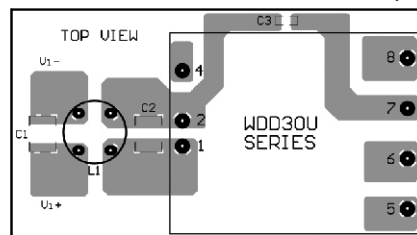

### RECOMMENDED CIRCUIT

The components used in the above figure, together with the manufacturer part numbers for these components, are as follows.

	C1	C2	C3	LI
WDD30-XXX1U	3.3 $\mu$ F / 50V MLCC	3.3 $\mu$ F / 50V MLCC	InF / 2KV MLCC	1.5mH Common Choke
WDD30-XXX2U	1.5 $\mu$ F / 50V MLCC	1.5 $\mu$ F / 50V MLCC	InF / 2KV MLCC	3.5mH Common Choke
WDD30-XXX3U	3.3 $\mu$ F / 100V MLCC	3.3 $\mu$ F / 100V MLCC	InF / 2KV MLCC	0.5mH Common Choke

### DERATING CURVE

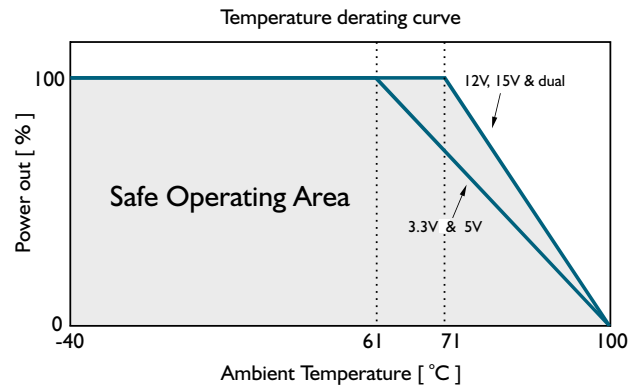

### EFFICIENCY CURVE

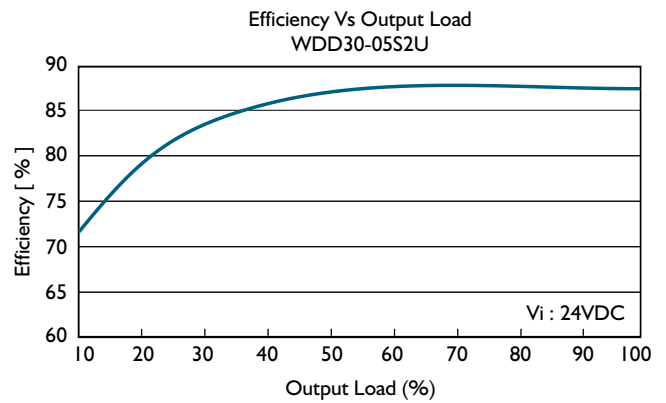
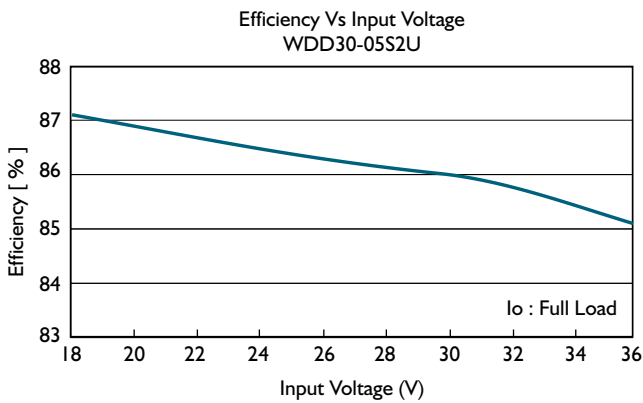

### Fig. 1 Trim connection

( For Single output )

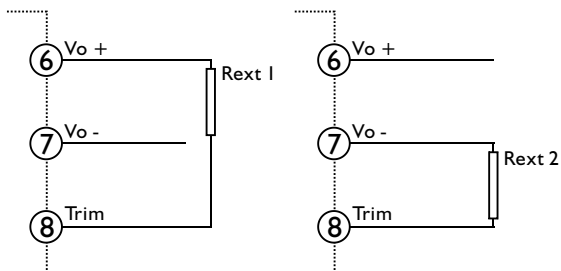

( For Dual output )

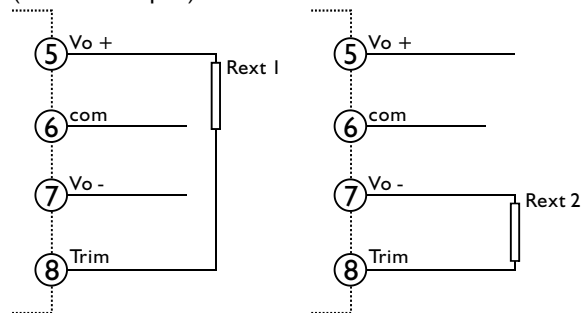

Table 1 Typical resistor values for various output voltage adjustment settings

Type	Rext 1		Rext 2	
	Vo nom -2.5%	Vo nom -5%	Vo nom +2.5%	Vo nom +5%
WDD30-03SXU	20K $\Omega$	0 $\Omega$	30K $\Omega$	5.6K $\Omega$
Type	Vo nom -5%	Vo nom -10%	Vo nom +5%	Vo nom +10%
WDD30-05SXU	5.6K $\Omega$	0 $\Omega$	1.5K $\Omega$	1K $\Omega$
WDD30-12SXU	43K $\Omega$	20K $\Omega$	10K $\Omega$	1K $\Omega$
WDD30-15SXU	120K $\Omega$	56K $\Omega$	24K $\Omega$	4.7K $\Omega$
WDD30-05DXU	330K $\Omega$	150K $\Omega$	10K $\Omega$	3K $\Omega$
WDD30-12DXU	130K $\Omega$	56K $\Omega$	10K $\Omega$	2K $\Omega$
WDD30-15DXU	130K $\Omega$	68K $\Omega$	15K $\Omega$	2K $\Omega$